

PRODUCTO	PÁGINA
ENGRANES EN EXISTENCIA	G-2
ENGRANES FABRICADOS SOBRE PEDIDO	G-3
NOMENCLATURA DE ENGRANES EN EXISTENCIA	G-4
TIPOS DE ENGRANES RECTOS	G-5
ENGRANES RECTOS (14½°)	G-6 – G-24
3DP.....	G-6 – G-7
4DP.....	G-8 – G-9
5DP.....	G-10 – G-11
6DP.....	G-12 – G-13
8DP.....	G-14 – G-15
10DP.....	G-16 – G-17
12DP.....	G-18 – G-19
16DP.....	G-20 – G-21
20DP.....	G-22 – G-23
24DP.....	G-24
CAPACIDAD DE POTENCIA HP DE LOS ENGRANES RECTOS (14½°)	G-25 – G-27
ENGRANES RECTOS (20°)	G-28 – G-43
4DP.....	G-28
5DP.....	G-29
6DP.....	G-30
8DP.....	G-31
10DP.....	G-32
12DP.....	G-33
16DP.....	G-34
20DP.....	G-35
CAPACIDAD DE POTENCIA HP DE LOS ENGRANES RECTOS (20°)	G-36 – G-43
CREMALLERAS MAQUINADAS	G-44 – G-45
ENGRANES CÓNICOS RECTOS (20°)	G-46 – G-48
CAPACIDAD DE POTENCIA HP DE ENGRANES CÓNICOS RECTOS.....	G-49
ENGRANES CÓNICOS REL. 1:1 (20°)	G-50 – G-55
CAPACIDAD DE POTENCIA HP DE ENGRANES CÓNICOS REL. 1:1.....	G-56
CORONAS Y SINFINES	G-57
3DP.....	G-58
4DP.....	G-59
6DP.....	G-60 – G-62
8DP.....	G-63 – G-65
10DP.....	G-66 – G-68
12DP.....	G-69 – G-71
16DP.....	G-72 – G-74
CAPACIDAD DE POTENCIA HP DE CORONAS Y SINFINES.....	G-75 – G-77
TOLERANCIAS ESTÁNDAR DE LOS ENGRANES	G-78
INGENIERÍA DE ENGRANES	G-79
SELECCIÓN DE TRANSMISIÓN DE ENGRANES.....	G-80 – G-82
FÓRMULAS PARA CÁLCULO DE POTENCIA HP.....	G-83
ESTÁNDARES DE ENGRANES.....	G-84
FÓRMULAS PARA ENGRANES RECTOS.....	G-85 – G-90
FÓRMULAS PARA ENGRANES CÓNICOS RECTOS Y CÓNICOS REL. 1:1.....	G-91
FÓRMULAS PARA CORONAS Y SINFINES.....	G-92
PERFIL DEL DIENTES DE LOS ENGRANES RECTOS (14½°)	G-93 – G-95
MATERIALES DE CONSTRUCCIÓN PARA ENGRANES RECTOS	G-96



Engranes Rectos



Engranes Cónicos



Engranes Cónicos
Relación 1:1



Corona y Sinfín



Cremallera



Nomenclatura de Engranés en Existencia

Las letras (Prefijo) indican el material de construcción y el tipo del engrane.

Las letras (Sufijo) indican dientes endurecidos, número de cuerdas, dirección de rotación y el cuñero y los opresores.

Los números indican el paso, el número de dientes y la relación de velocidad (como sufijo).



Engranés Rectos

S = Acero

TS = Acero 20°

C = Fundición

TC = Fundición 20°

H = Dientes Endurecidos

NM = No Metálico

Nota: El ángulo de presión se indica como un sufijo en el número de parte.

Ejemplos

S620-14½° (Acero 6P 20D-14½°AP)

TS620-20° (Acero 6P 20D-20°AP)

C660-14½° (Fundido 6P 60D-14½°AP)

TC660-20° (Fundido 6P 60D-20°AP)

S620H-14½° (Acero 6P 20D-Endurecidos
14½°AP)

NM620-14½° (No Metálico 6P 20D-14½°AP)



Cremallera

R = Cremallera — Acero

RA = Cremallera — Acero Soporte Pesado

TR = Cremallera — Acero 20° Soporte Pesado

R20 = Cremallera — Acero 20° Cara Ancha

Ejemplos

R-6X2 (14½° Soporte Estándar 6PX2' Largo)

RA-6X4 (14½° Soporte Pesado 6PX4' Largo)

TR-6X6 (20° Estándar con 6PX6' Largo)

R20-6X6 (20° Cara Ancha 6PX6' Largo)



Engranés Cónicos

B= Cónicos – Engranés de Hierro Fundido

B= Cónicos – Piñón de Acero

BS = Cónicos – Engranés de Acero

BS = Cónicos – Piñón de Acero

Nota: Los piñones B de acero pueden operar con los engranes BS de la misma relación.

Ejemplos

B1040-2 (Fundido 10P 40D Relación de 2:1)

B1020-3 (Acero 10P 20D Relación de 2:1)

BS1040-2 (Acero 10P 40D Relación de 2:1)

BS1020-2 (Acero 10P 20D Relación de 2:1)



Engranés Cónicos Rel. 1:1

M = Engranajes Cónicos – Acero

A o B = Mayor Barreno (Sufijo)

HM = Cónicos 1:1 – Dientes Endurecidos

K = Cuñero y Opresor

Ejemplos

M824 (Acero 8P 24D)

M824A (Acero 8P 24D Barreno Mayor)

M2424BR (Bronce 24P 24D)

HM1020 (Dientes Endurecidos de Acero 10P
20D)

HMK1020 (Acero Endurecido 10P 24D con
Cuñero y Opresor)



Sinfines

W = Sinfines – Acero

WH = Sinfines – Acero con Proyección
de Mazas

WG = Sinfines – Acero con Cuerdas
Endurecidas y Pulidas

WHG = Sinfines – Acero con Cuerdas
Endurecidas y Pulidas con
Proyección de Mazas

L = (Prefijo) Cara Mayor

D o Q = (Sufijo) Cuerda Doble o Cuádruple

R = Mano Derecha

Ejemplos

W6R (Acero 6P Mano Derecha)

WH6R (Acero con Proyección de Maza 6P
Mano Derecha)

WG6R (Acero con Cuerda Endurecida 6P
Mano Derecha)

WHG6R (Acero con Proyección de Maza y
Cuerda Endurecida 6P Mano
Derecha)

LW6R (Cara Mayor de Acero 6P Mano
Derecha)

W6DR (Acero 6P Cuerda Doble Mano
Derecha)



Coronas

W = Corona – Hierro Fundido

WB = Corona – Bronce

D o Q = (Sufijo) Cuerda Doble o Cuádruple (Sufijo)

R = Mano Derecha (Sufijo)

Ejemplos

W660R (Hierro Fundido 6P 60D Mano
Derecha)

WB660R (Bronce 6P 60D Mano Derecha)

W660DR (Hierro Fundido 6P 60D Cuerda
Doble Mano Derecha)

Los Engranes Rectos en Existencia de *Martin*, están disponibles en 5 tipos diferentes. Los Engranes de Acero se suministran como tipo Sencillo y Sencillo con Maza. Los Engranes de Hierro Fundido se suministran como tipo Sencillo con Maza, con Alma y Barrenos de Aligeramiento y con Rayos. Los Engranes Fundidos están maquinados en todas las superficies de operación. Los Engranes de Hierro Fundido de *Martin* tienen una maza mayor para proporcionar más fuerza y permitir un mayor diámetro de barreno.



Tipo A

- Sencillo sin Mazas
- De Acero



Tipo B₁

- Con Alma
- De Acero
- De Hierro Fundido



Tipo B

- Sencillo con Maza
- De Acero
- De Hierro Fundido



Tipo B₂

- Con Alma y Barrenos de Aligeramiento
- De Acero
- De Hierro Fundido



Tipo B₃

- Con Alma y Rayos
- De Hierro Fundido

3 DP Cara 3"

Engranos Rectos de Acero en Existencia

Ángulo de Presión 14½°



Tipo A
Sencillo sin Maza



Tipo B
Sencillo con Maza



Tipo B₁
Con Alma



Tipo B₂
Con Alma y Barrenos de Aligeramiento

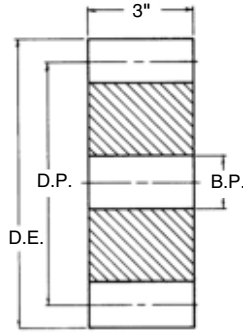

Tipo A

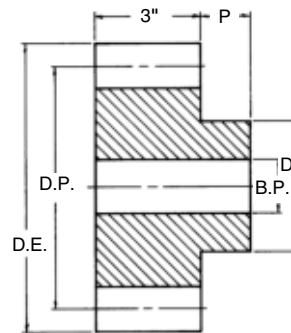

Tipo B

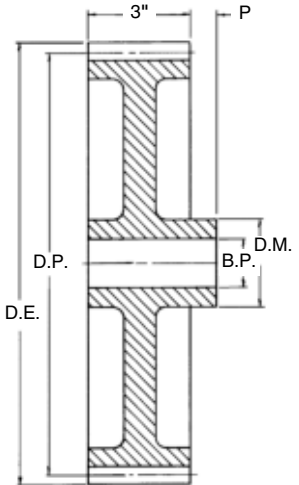

Tipo B₁, B₂

Acero

Número de Dientes	Número de Parte	Ángulo de Presión	Diámetro		Tipo	Barreno (Pulg.)		Maza (Pulg.)		Peso Aprox. (lb)
			Paso	Exterior		Piloto	Máx.*	Diámetro	Proy.	
11	S311	14½	4.000¥†	4.666	A	1⅛	2			12.0
12	S312	14½	4.000¥	4.666	A	1⅛	2			11.0
13	S313	14½	4.333	5.000	A	1⅛	2¼			10.7
14	S314	14½	4.667	5.333	A	1⅛	2½			12.8
15	S315	14½	5.000	5.666	A	1⅛	2¾			14.8
16	S316	14½	5.333	6.000	A	1⅛	2⅞			17.0
18	S318	14½	6.000	6.666	A	1⅛	3¼			22.0
20	S320	14½	6.667	7.333	A	1⅛	3½			27.4
21	S321	14½	7.000	7.666	A	1⅛	3¾			30.7
24	S324	14½	8.000	8.666	B	1⅛	3¼	5½	1¼	48.2
30	S330	14½	10.000	10.666	B	1⅛	3¾	6¼	1¼	74.5
36	S336	14½	12.000	12.666	B	1⅛	4¼	6½	1¼	114
42	S342	14½	14.000	14.666	B ₁	1⅛	4¾	6½	1¼	106
48	S348	14½	16.000	16.666	B ₁	1⅛	4¾	6½	1¼	120
54	S354	14½	18.000	18.666	B ₂	1⅛	4¾	6½	1¼	134
60	S360	14½	20.000	20.666	B ₂	1⅛	4¾	6½	1¼	150
72	S372	14½	24.000	24.666	B ₂	1⅛	4¾	7	1¼	180
84	S384	14½	28.000	28.666	B ₂	1⅛	4¾	7	1¼	215
96	S396	14½	32.000	32.666	B ₂	1⅞	4¾	7	1¼	264
108	S3108	14½	36.000	36.666	B ₂	1⅞	4¾	7	1¼	305
120	S3120	14½	40.000	40.666	B ₂	1⅞	5	7½	1¼	367

Los engranes con ángulo de presión de 14½° no operan con engranes con ángulo de presión de 20°.

*Barreno máximo recomendado con cuñero y opresor.

† Diámetro de paso alargado con forma especial del diente.

¥ Cara de 4"



Tipo B
Sencillo con Maza



Tipo B₂
Con Alma y Barrenos de Aligeramiento



Tipo B₃
Con Alma y Rayos

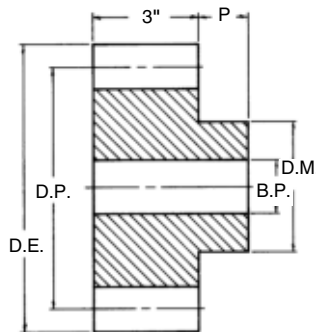

Tipo B

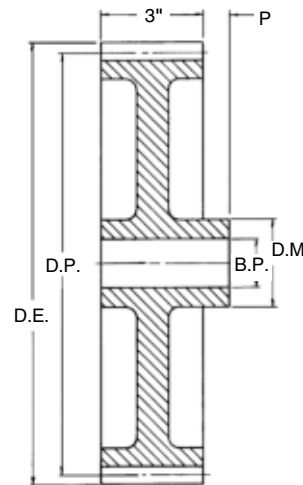

Tipo B₂, B₃

Hierro Fundido — Estilo "B"

Número de Dientes	Número de Parte	Ángulo de Presión	Diámetro		Tipo	Barreno (Pulg.)		Maza (Pulg.)		Peso Aprox. (lb)
			Paso	Exterior		Piloto	Máx.*	Diámetro	Proy.	
24	C324	14½	8.000	8.666	B	1⅛	2⅛	4½	1¼	40.4
28	C328	14½	9.333	10.000	B	1⅛	3⅛	5¼	1¼	54.2
30	C330	14½	10.000	10.666	B	1⅛	3⅛	5¼	1¼	57.1
32	C332	14½	10.667	11.333	B	1⅛	3⅛	5¼	1¼	62.4
36	C336	14½	12.000	12.666	B ₂	1⅛	3¼	5½	1¼	71.3
40	C340	14½	13.333	14.000	B ₂	1⅛	3¼	5½	1¼	75.9
42	C342	14½	14.000	14.666	B ₂	1⅛	3¼	5½	1¼	79.5
45	C345	14½	15.000	15.666	B ₂	1⅛	3¼	5½	1¼	85.0
48	C348	14½	16.000	16.666	B ₃	1⅛	3¼	5½	1¼	92.9
54	C354	14½	18.000	18.666	B ₃	1⅛	3¼	5½	1¼	104
60	C360	14½	20.000	20.666	B ₃	1⅛	3¼	5½	1¼	115
72	C372	14½	24.000	24.666	B ₃	1⅛	3⅜	6	1¼	153
75	C375	14½	25.000	25.666	B ₃	1⅞	3⅜	6	1¼	155
84	C384	14½	28.000	28.666	B ₃	1⅞	3⅜	6	1¼	178
90	C390	14½	30.000	30.666	B ₃	1⅞	3⅜	6	1¼	185
96	C396	14½	32.000	32.666	B ₃	1⅞	3⅜	6	1¼	205
105	C3105	14½	35.000	35.666	B ₃	1⅞	3⅜	6	1¼	216
108	C3108	14½	36.000	36.666	B ₃	1⅞	3⅜	6	1¼	228
120	C3120	14½	40.000	40.666	B ₃	1⅞	4¼	6½	1¼	226

Los engranes con ángulo de presión de 14½° no operan con engranes con ángulo de presión de 20°.

*Barreno Máximo recomendado con cuñero y opressor.

4 DP Cara 2"

Engranos Rectos de Acero en Existencia

Ángulo de Presión 14½°

Martin



Tipo B
Sencillo con Maza



Tipo B₁
Con Alma



Tipo B₂
Con Alma y Barrenos de Aligeramiento

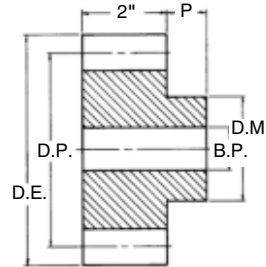

Tipo B

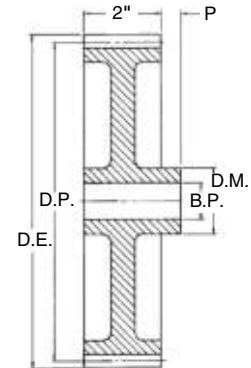

Tipo B₁, B₂

Acero

Número de Dientes	Número de Parte	Ángulo de Presión	Diámetro		Tipo	Barreno (Pulg.)		Maza (Pulg.)		Peso Aprox. (lb)
			Paso	Exterior		Piloto	Máx.*	Diámetro	Proy.	
11	S411	14½	3.000†	3.500	B	1½	1⅞	2¼	⅞	4.0
12	S412	14½	3.000	3.500	B	1½	1⅞	2¼	⅞	3.9
13	S413	14½	3.250	3.750	B	1½	1⅞	2¼	⅞	4.6
14	S414	14½	3.500	4.000	B	1½	1½	2¼	⅞	5.7
15	S415	14½	3.750	4.250	B	1½	1½	3	⅞	6.8
16	S416	14½	4.000	4.500	B	1½	1½	3¼	⅞	8.0
17	S417	14½	4.250	4.750	B	1½	2	3½	⅞	9.2
18	S418	14½	4.500	5.000	B	1½	2¼	3¾	⅞	10.4
19	S419	14½	4.750	5.250	B	1½	2¼	4	⅞	10.5
20	S420	14½	5.000	5.500	B	1½	2½	4¼	⅞	13.4
21	S421	14½	5.250	5.750	B	1½	2½	4½	⅞	14.9
22	S422	14½	5.500	6.000	B	1½	2½	4¾	⅞	16.5
24	S424	14½	6.000	6.500	B	1½	2¾	4¾	1½	22.8
26	S426	14½	6.500	7.000	B	1½	2¾	4¾	1½	24.8
28	S428	14½	7.000	7.500	B	1½	2¾	4¾	1½	27.8
30	S430	14½	7.500	8.000	B	1½	2¾	4¾	1½	31.0
32	S432	14½	8.000	8.500	B	1½	2¾	4¾	1½	34.4
36	S436	14½	9.000	9.500	B	1½	2¾	4¾	1½	41.7
40	S440	14½	10.000	10.500	B	1½	3½	5½	1½	51.8
42	S442	14½	10.500	11.000	B	1½	3½	5½	1½	56.0
44	S444	14½	11.000	11.500	B	1½	3½	5½	1½	60.8
48	S448	14½	12.000	12.500	B	1½	3½	5½	1½	70.8
54	S454	14½	13.500	14.000	B ₁	1½	3	5	1½	57.4
56	S456	14½	14.000	14.500	B ₁	1½	3	5	1½	59.9
60	S460	14½	15.000	15.500	B ₂	1½	3	5	1½	62.8
64	S464	14½	16.000	16.500	B ₂	1½	3	5	1½	66.2
72	S472	14½	18.000	18.500	B ₂	1½	3¼	5½	1½	82.9
80	S480	14½	20.000	20.500	B ₂	1½	3¼	5½	1½	95.0
84	S484	14½	21.000	21.500	B ₂	1½	3¼	5½	1½	92.0
88	S488	14½	22.000	22.500	B ₂	1½	3¼	6½	1½	95.8
96	S496	14½	24.000	24.500	B ₂	1½	3¼	6½	1½	124
120	S4120	14½	30.000	30.500	B ₂	1½	3¾	6	1½	155
144	S4144	14½	36.000	36.500	B ₂	1½	4	6½	1½	208

Los engranes con ángulo de presión de 14½° no operan con engranes con ángulo de presión de 20°.

* Barreno Máximo recomendado con cuñero y opresor.

† Diámetro de paso alargado con forma especial del diente.

Martin

Engranos Rectos de Hierro Fundido en Existencia

Ángulo de Presión 14½°

4 DP Cara 2"



Tipo B
Sencillo con Maza



Tipo B₁
Con Alma



Tipo B₂
Con Alma y Barrenos de Aligeramiento



Tipo B₃
Con Alma y Rayos

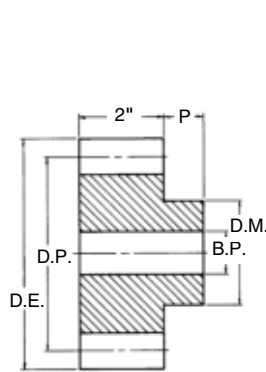

Tipo B

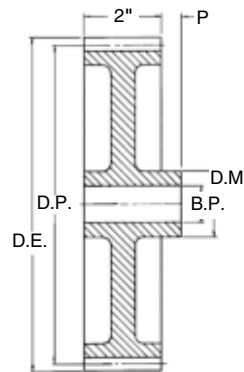

Tipo B₁, B₂, B₃

Hierro Fundido — Estilo “B”

Número de Dientes	Número de Parte	Ángulo de Presión	Diámetro		Tipo	Barreno (Pulg.)		Maza (Pulg.)		Peso Aprox. (lb)
			Paso	Exterior		Piloto	Máx.*	Diámetro	Proy.	
24	C424	14½	6.000	6.500	B	1½	2½	3½	1½	17.0 v
28	C428	14½	7.000	7.500	B ₁	1½	2½	3½	1½	20.2
30	C430	14½	7.500	8.000	B ₁	1½	2½	3½	1½	21.1
32	C432	14½	8.000	8.500	B ₁	1½	2½	3½	1½	23.2
36	C436	14½	9.000	9.500	B ₂	1½	2½	3½	1½	30.5
40	C440	14½	10.000	10.500	B ₂	1½	2½	4	1½	26.4
42	C442	14½	10.500	11.000	B ₂	1½	2½	4	1½	33.9
44	C444	14½	11.000	11.500	B ₂	1½	2½	4	1½	32.0
48	C448	14½	12.000	12.500	B ₃	1½	2½	4	1½	38.4
52	C452	14½	13.000	13.500	B ₃	1½	2½	4	1½	42.5
54	C454	14½	13.500	14.000	B ₃	1½	2½	4	1½	44.7
56	C456	14½	14.000	14.500	B ₃	1½	2½	4	1½	46.7
60	C460	14½	15.000	15.500	B ₃	1½	2½	4	1½	49.5
64	C464	14½	16.000	16.500	B ₃	1½	2½	4	1½	54.5
68	C468	14½	17.000	17.500	B ₃	1½	2½	4	1½	56.0
72	C472	14½	18.000	18.500	B ₃	1½	2½	4½	1½	63.0
80	C480	14½	20.000	20.500	B ₃	1½	2½	4½	1½	72.0
84	C484	14½	21.000	21.500	B ₃	1½	2½	4½	1½	73.0
88	C488	14½	22.000	22.500	B ₃	1½	2½	4½	1½	75.0
96	C496	14½	24.000	24.500	B ₃	1½	2½	4½	1½	86.0
100	C4100	14½	25.000	25.500	B ₃	1½	2½	4½	1½	91.0
104	C4104	14½	26.000	26.500	B ₃	1½	2½	4½	1½	105
112	C4112	14½	28.000	28.500	B ₃	1½	3½	5	1½	108
120	C4120	14½	30.000	30.500	B ₃	1½	3½	5	1½	115
132	C4132	14½	33.000	33.500	B ₃	1½	3½	5	1½	129
144	C4144	14½	36.000	36.500	B ₃	1½	3½	5½	1½	140

Los engranes con ángulo de presión de 14½° no operan con engranes con ángulo de presión de 20°.

*Barreno Máximo recomendado con cuñero y opresor.

5 DP Cara 1³/₄"

Engranos Rectos de Acero en Existencia

Ángulo de Presión 14¹/₂°

Martin



Tipo B
Sencillo con Maza



Tipo B₂
Con Alma y Barrenos de Aligeramiento

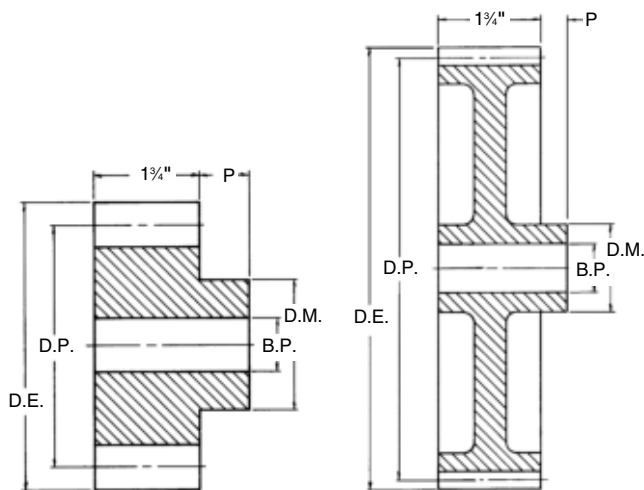

Tipo B

Tipo B₂

Acero

Número de Dientes	Número de Parte	Ángulo de Presión	Diámetro		Tipo	Barreno (Pulg.)		Maza (Pulg.)		Peso Aprox. (lb)
			Paso	Exterior		Piloto	Máx.*	Diámetro	Proy.	
11	S511	14 ¹ / ₂	2.400†	2.800	B	1 ¹ / ₁₆	1 ¹ / ₁₆	1 ⁵ / ₃₂	7 ¹ / ₈	2.0
12	S512	14 ¹ / ₂	2.400	2.800	B	1 ¹ / ₁₆	1 ¹ / ₁₆	1 ⁵ / ₃₂	7 ¹ / ₈	2.0
13	S513	14 ¹ / ₂	2.600	3.000	B	1 ¹ / ₁₆	1 ¹ / ₄	2	7 ¹ / ₈	2.6
14	S514	14 ¹ / ₂	2.800	3.200	B	1 ¹ / ₁₆	1 ¹ / ₁₆	2 ¹ / ₁₆	7 ¹ / ₈	3.1
15	S515	14 ¹ / ₂	3.000	3.400	B	1 ¹ / ₁₆	1 ¹ / ₁₆	2 ¹ / ₈	7 ¹ / ₈	3.7
16	S516	14 ¹ / ₂	3.200	3.600	B	1 ¹ / ₁₆	1 ¹ / ₈	2 ¹ / ₁₆	7 ¹ / ₈	4.5
17	S517	14 ¹ / ₂	3.400	3.800	B	1 ¹ / ₁₆	1 ¹ / ₁₆	2 ¹ / ₈	7 ¹ / ₈	5.2
18	S518	14 ¹ / ₂	3.600	4.000	B	1 ¹ / ₁₆	1 ¹ / ₈	3	7 ¹ / ₈	5.9
19	S519	14 ¹ / ₂	3.800	4.200	B	1 ¹ / ₁₆	2 ¹ / ₁₆	3 ¹ / ₁₆	7 ¹ / ₈	6.7
20	S520	14 ¹ / ₂	4.000	4.400	B	1 ¹ / ₁₆	2 ¹ / ₈	3 ¹ / ₈	7 ¹ / ₈	7.5
21	S521	14 ¹ / ₂	4.200	4.600	B	1 ¹ / ₁₆	2 ¹ / ₈	3 ¹ / ₈	7 ¹ / ₈	8.1
22	S522	14 ¹ / ₂	4.400	4.800	B	1 ¹ / ₁₆	2 ¹ / ₈	3 ¹ / ₈	7 ¹ / ₈	8.8
23	S523	14 ¹ / ₂	4.600	5.000	B	1 ¹ / ₁₆	2 ¹ / ₈	3 ¹ / ₈	7 ¹ / ₈	9.5
24	S524	14 ¹ / ₂	4.800	5.200	B	1 ¹ / ₁₆	2 ¹ / ₈	3 ¹ / ₈	1 ¹ / ₄	11.0
25	S525	14 ¹ / ₂	5.000	5.400	B	1 ¹ / ₁₆	2 ¹ / ₈	3 ¹ / ₈	1 ¹ / ₄	11.8
26	S526	14 ¹ / ₂	5.200	5.600	B	1 ¹ / ₁₆	2 ¹ / ₈	3 ¹ / ₈	1 ¹ / ₄	12.9
28	S528	14 ¹ / ₂	5.600	6.000	B	1 ¹ / ₁₆	2 ¹ / ₈	3 ¹ / ₈	1 ¹ / ₄	14.3
30	S530	14 ¹ / ₂	6.000	6.400	B	1 ¹ / ₁₆	2 ¹ / ₈	3 ¹ / ₈	1 ¹ / ₄	16.0
35	S535	14 ¹ / ₂	7.000	7.400	B	1 ¹ / ₁₆	2 ¹ / ₈	4 ¹ / ₁₆	1 ¹ / ₄	22.8
40	S540	14 ¹ / ₂	8.000	8.400	B	1 ¹ / ₁₆	2 ¹ / ₈	4 ¹ / ₁₆	1 ¹ / ₄	28.5
45	S545	14 ¹ / ₂	9.000	9.400	B	1 ¹ / ₁₆	2 ¹ / ₁₆	4 ¹ / ₈	1 ¹ / ₄	35.0
50	S550	14 ¹ / ₂	10.000	10.400	B	1 ¹ / ₁₆	2 ¹ / ₁₆	4 ¹ / ₈	1 ¹ / ₄	43.6
55	S555	14 ¹ / ₂	11.000	11.400	B	1 ¹ / ₁₆	2 ¹ / ₁₆	4 ¹ / ₈	1 ¹ / ₄	52.0
60	S560	14 ¹ / ₂	12.000	12.400	B	1 ¹ / ₁₆	2 ¹ / ₁₆	4 ¹ / ₈	1 ¹ / ₄	60.9
70	S570	14 ¹ / ₂	14.000	14.400	B ₂	1 ¹ / ₁₆	3 ¹ / ₈	5	1 ¹ / ₄	48.4
80	S580	14 ¹ / ₂	16.000	16.400	B ₂	1 ¹ / ₁₆	3 ¹ / ₈	5	1 ¹ / ₄	57.0
90	S590	14 ¹ / ₂	18.000	18.400	B ₂	1 ¹ / ₁₆	3 ¹ / ₈	5	1 ¹ / ₄	67.0
100	S5100	14 ¹ / ₂	20.000	20.400	B ₂	1 ¹ / ₁₆	3 ¹ / ₈	5 ¹ / ₂	1 ¹ / ₂	62.0
110	S5110	14 ¹ / ₂	22.000	22.400	B ₂	1 ¹ / ₁₆	3 ¹ / ₈	5 ¹ / ₂	1 ¹ / ₂	87.6
120	S5120	14 ¹ / ₂	24.000	24.400	B ₂	1 ¹ / ₁₆	3 ¹ / ₂	6 ¹ / ₈	1 ¹ / ₂	113

Los engranes con ángulo de presión de 14¹/₂° no operan con engranes con ángulo de presión de 20°.

* Barreno Máximo recomendado con cuñero y opresor.

† Diámetro de paso alargado con forma especial del diente.

Martin

Engranos Rectos de Hierro Fundido en Existencia

Ángulo de Presión de 14½°

5 DP

Cara 1¾"



Tipo B
Sencillo con Maza



Tipo B₁
Con Alma



Tipo B₂
Con Alma y Barrenos de Aligeramiento



Tipo B₃
Con Alma y Rayos

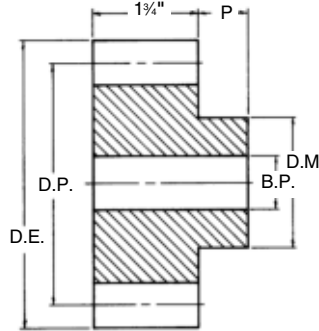

Tipo B

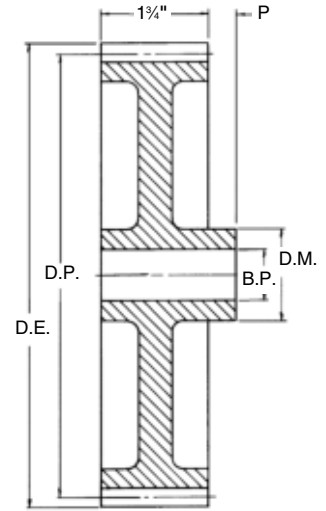

Tipo B₁, B₂, B₃

Hierro Fundido — Estilo “B”

Número de Dientes	Número de Parte	Ángulo de Presión	Diámetro		Tipo	Barreno (Pulg.)		Maza (Pulg.)		Peso Aprox. (lb)
			Paso	Exterior		Piloto	Máx.*	Diámetro	Proy.	
24	C524	14½	4.800	5.200	B	1⅛	2⅛	3¼	1¼	9.9
25	C525	14½	5.000	5.400	B	1⅛	2⅛	3¼	1¼	10.6
28	C528	14½	5.600	6.000	B ₁	1⅛	2⅛	3¼	1¼	12.1
30	C530	14½	6.000	6.400	B ₁	1⅛	2⅛	3¼	1¼	13.9
32	C532	14½	6.400	6.800	B ₁	1⅛	2⅛	3¼	1¼	13.5
35	C535	14½	7.000	7.400	B ₁	1⅛	2⅛	3¼	1¼	16.9
36	C536	14½	7.200	7.600	B ₁	1⅛	2⅛	3¼	1¼	15.5
40	C540	14½	8.000	8.400	B ₁	1⅛	2⅛	3¼	1¼	17.4
45	C545	14½	9.000	9.400	B ₂	1⅛	2⅛	3¼	1¼	20.3
48	C548	14½	9.600	10.000	B ₂	1⅛	2⅛	3¼	1¼	25.2
50	C550	14½	10.000	10.400	B ₃	1⅛	2⅛	3¼	1¼	23.7
54	C554	14½	10.800	11.200	B ₃	1⅛	2⅛	3¼	1¼	25.1
55	C555	14½	11.000	11.400	B ₃	1⅛	2⅛	3¼	1¼	26.0
60	C560	14½	12.000	12.400	B ₃	1⅛	2⅛	3¼	1¼	30.6
64	C564	14½	12.800	13.200	B ₃	1⅛	2⅛	3¼	1¼	31.2
66	C566	14½	13.200	13.600	B	1⅛	2⅛	3¼	1¼	30.8
70	C570	14½	14.000	14.400	B ₃	1⅛	2⅛	4	1¼	34.5
72	C572	14½	14.400	14.800	B ₃	1⅛	2⅛	4	1¼	35.0
75	C575	14½	15.000	15.400	B ₃	1⅛	2⅛	4	1¼	36.7
80	C580	14½	16.000	16.400	B ₃	1⅛	2⅛	4	1¼	40.8
84	C584	14½	16.800	17.200	B ₃	1⅛	2⅛	4	1¼	40.0
90	C590	14½	18.000	18.400	B ₃	1⅛	2⅛	4	1¼	45.4
96	C596	14½	19.200	19.600	B ₃	1⅛	2⅛	4	1¼	48.6
100	C5100	14½	20.000	20.400	B ₃	1⅛	2⅛	4½	1½	54.4
120	C5120	14½	24.000	24.400	B ₃	1⅛	2⅜	4¾	1½	56.1
130	C5130	14½	26.000	26.400	B ₃	1⅛	2⅞	4¾	1½	70.2

Los engranes con ángulo de presión de 14½° no operan con engranes con ángulo de presión de 20°.

- * Barreno máximo recomendado con cuñero y opressor.
- Para información de grandes cantidades de tamaños descontinuados de hierro fundido, contacte a la fábrica *Martin* más cercana.

6 DP Cara 1½"

Engranos Rectos de Acero en Existencia

Ángulo de Presión de 14½°



Tipo B
Sencillo con Maza



Tipo B₂
Con Alma y Barrenos de
Aligeramiento

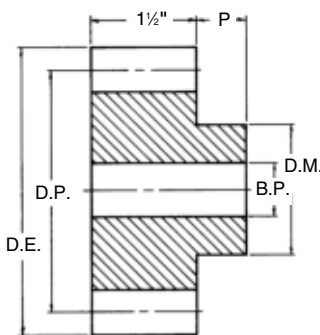

Tipo B

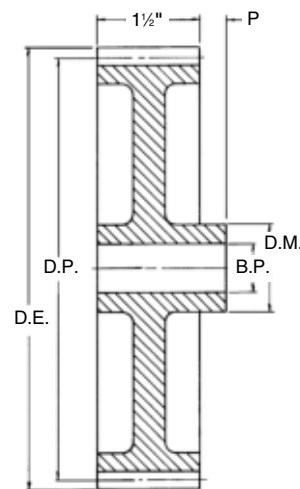

Tipo B₂

Acero

Número de Dientes	Número de Parte	Ángulo de Presión	Diámetro		Tipo	Barreno (Pulg.)		Maza (Pulg.)		Peso Aprox. (lb)
			Paso	Exterior		Piloto	Máx.*	Diámetro	Proy.	
11	S611	14½	2.000†	2.333	B	1	**	1½	¾	1.1
12	S612	14½	2.000	2.333	B	1	**	1½	¾	1.1
14	S614	14½	2.333	2.666	B	1	1¼	1 11/16	¾	1.8
15	S615	14½	2.500	2.833	B	1	1¼	2	¾	2.2
16	S616	14½	2.666	3.000	B	1	1¼	2 1/2	¾	2.6
18	S618	14½	3.000	3.333	B	1	1½	2½	¾	3.5
20	S620	14½	3.333	3.666	B	1	1½	2 3/4	¾	4.6
21	S621	14½	3.500	3.833	B	1	1½	3	¾	5.1
22	S622	14½	3.666	4.000	B	1	1½	3	¾	5.5
24	S624	14½	4.000	4.333	B	1½	1½	3	1	6.5
27	S627	14½	4.500	4.833	B	1½	1½	3	1	6.6
28	S628	14½	4.666	5.000	B	1½	1½	3	1	8.3
30	S630	14½	5.000	5.333	B	1½	2	3½	1	9.5
32	S632	14½	5.333	5.666	B	1½	2	3½	1	10.7
33	S633	14½	5.500	5.833	B	1½	2½	3½	1	11.3
36	S636	14½	6.000	6.333	B	1½	2½	3½	1	13.3
39	S639	14½	6.500	6.833	B	1½	2½	4	1	16.6
40	S640	14½	6.666	7.000	B	1½	2½	4	1	17.6
42	S642	14½	7.000	7.333	B	1½	2½	4	1	18.9
45	S645	14½	7.500	7.833	B	1½	2½	4	1	21.3
48	S648	14½	8.000	8.333	B	1½	2½	4½	1	24.3
52	S652	14½	8.666	9.000	B	1½	2½	4½	1	27.9
54	S654	14½	9.000	9.333	B	1½	2½	4½	1	30.4
58	S658	14½	9.666	10.000	B	1½	2½	4½	1	33.9
60	S660	14½	10.000	10.333	B	1½	2½	4½	1½	34.3
64	S664	14½	10.666	11.000	B	1½	2½	4½	1½	42.2
66	S666	14½	11.000	11.333	B	1½	2½	4½	1½	50.0
72	S672	14½	12.000	12.333	B	1½	2 11/16	4½	1½	53.0
84	S684	14½	14.000	14.333	B ₂	1½	2 11/16	4½	1½	40.0
96	S696	14½	16.000	16.333	B ₂	1½	2 11/16	5½	1½	43.8
108	S6108	14½	18.000	18.333	B ₂	1½	2 11/16	5½	1½	53.0
120	S6120	14½	20.000	20.333	B ₂	1½	2 11/16	5½	1½	63.2
132	S6132	14½	22.000	22.333	B ₂	1½	2 11/16	5	1½	68.3
144	S6144	14½	24.000	24.333	B ₂	1½	3	5	1½	82.7

Los engranes con ángulo de presión de 14½° no operan con engranes con ángulo de presión de 20°.

* Barreno máximo recomendado con cuñero y opresor.

** Consulte a *Martin*.

† Diámetro de paso alargado con forma especial del diente.

Martin

Engranos Rectos de Hierro Fundido en Existencia

Ángulo de Presión de 14½°

6 DP Cara 1½"



Tipo B Sencillo con Maza



Tipo B₁ Con Alma



Tipo B₂
Con Alma y Barrenos de Aligeramiento



Tipo B₃
Con Alma y Rayos

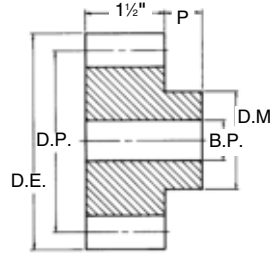

Tipo B

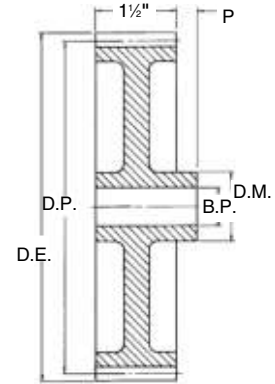

Tipo B₁, B₂, B₃

Hierro Fundido — Estilo "B"

Número de Dientes	Número de Parte	Ángulo de Presión	Diámetro		Tipo	Barreno (Pulg.)		Maza (Pulg.)		Peso Aprox. (lb)
			Paso	Exterior		Piloto	Máx.*	Diámetro	Proy.	
• 32	C632	14½	5.333	5.666	B ₁	1½	1⅞	2½	1	7.2
• 40	C640	14½	6.666	7.000	B ₁	1½	1⅞	3	1	11.9
• 42	C642	14½	7.000	7.333	B ₁	1½	1⅞	3	1	13.0
• 48	C648	14½	8.000	8.333	B ₃	1½	1⅞	3	1	12.1
• 54	C654	14½	9.000	9.333	B ₃	1½	2⅞	3¼	1	14.4
• 60	C660	14½	10.000	10.333	B ₃	1¼	2⅞	3¼	1¼	17.0
• 64	C664	14½	10.666	11.000	B ₃	1¼	2⅞	3¼	1¼	18.5
66	C666	14½	11.000	11.333	B ₃	1¼	2⅞	3¼	1¼	19.0
70	C670	14½	11.666	12.000	B ₃	1¼	2⅞	3¼	1¼	20.6
72	C672	14½	12.000	12.333	B ₃	1¼	2⅞	3½	1¼	23.7
75	C675	14½	12.500	12.833	B ₃	1¼	2⅞	3½	1¼	25.4
80	C680	14½	13.333	13.666	B ₃	1¼	2⅞	3½	1¼	25.8
84	C684	14½	14.000	14.333	B ₃	1¼	2⅞	3½	1¼	25.0
90	C690	14½	15.000	15.333	B ₃	1¼	2⅞	3½	1¼	25.8
96	C696	14½	16.000	16.333	B ₃	1¼	2⅞	3½	1¼	28.0
108	C6108	14½	18.000	18.333	B ₃	1¼	2⅞	3¾	1¼	32.0
120	C6120	14½	20.000	20.333	B ₃	1¼	2⅞	3¾	1½	34.8
132	C6132	14½	22.000	22.333	B ₃	1¼	2⅞	3¾	1½	43.4
144	C6144	14½	24.000	24.333	B ₃	1¼	2⅞	4	1½	45.2
180	C6180	14½	30.000	30.333	B ₃	1¼	2⅞	4	1½	58.3

* Barreno máximo recomendado con cuñero y opositor.

• Consulte a *Martin*.

Barreno a la Medida

Número de Dientes	Número de Parte	Ángulo de Presión	Diámetro		Tipo	Barreno (Pulg.)		Opositor	Maza (Pulg.)		Peso Aprox. (lb)
			Paso	Exterior		Piloto	Cuñero		Diámetro	Proy.	
11	S611BS 1	14½	2.000	2.333	B	1	¼ x ⅜	(1) 1/4-20 @90°	1½	⅞	1.10
12	S612BS 1	14½	2.000	2.333	B	1	¼ x ⅜	(1) 1/4-20 @90°	1½	⅞	1.10
14	S614BS 1	14½	2.333	2.667	B	1	¼ x ⅜	(1) 5/16-18 @90°	1⅞	⅞	1.80
14	S614BS 1-1/8	14½	2.333	2.667	B	1½	¼ x ⅜	(1) 5/16-18 @90°	1⅞	⅞	1.80
15	S615BS 1	14½	2.500	2.833	B	1	¼ x ⅜	(1) 5/16-18 @90°	2	⅞	2.20
15	S615BS 1-1/8	14½	2.500	2.833	B	1½	¼ x ⅜	(1) 5/16-18 @90°	2	⅞	2.20
15	S615BS 1-3/16	14½	2.500	2.833	B	1⅞	¼ x ⅜	(1) 5/16-18 @90°	2	⅞	2.20
15	S615BS 1-1/4	14½	2.500	2.833	B	1¼	¼ x ⅜	(1) 5/16-18 @90°	2	⅞	2.20
16	S616BS 1	14½	2.667	3.000	B	1	¼ x ⅜	(1) 5/16-18 @90°	2 ⅝	⅞	2.60
16	S616BS 1-1/8	14½	2.667	3.000	B	1½	¼ x ⅜	(1) 5/16-18 @90°	2 ⅝	⅞	2.60
16	S616BS 1-3/16	14½	2.667	3.000	B	1⅞	¼ x ⅜	(1) 5/16-18 @90°	2 ⅝	⅞	2.60
16	S616BS 1-1/4	14½	2.667	3.000	B	1¼	¼ x ⅜	(1) 5/16-18 @90°	2 ⅝	⅞	2.60
18	S618BS 1	14½	3.000	3.333	B	1	¼ x ⅜	(1) 5/16-18 @90°	2 ½	⅞	3.50
18	S618BS 1-1/8	14½	3.000	3.333	B	1½	¼ x ⅜	(1) 5/16-18 @90°	2 ½	⅞	3.50
18	S618BS 1-3/16	14½	3.000	3.333	B	1⅞	¼ x ⅜	(1) 5/16-18 @90°	2 ½	⅞	3.50
18	S618BS 1-1/4	14½	3.000	3.333	B	1¼	¼ x ⅜	(1) 5/16-18 @90°	2 ½	⅞	3.50
20	S620BS 1	14½	3.333	3.667	B	1	¼ x ⅜	(1) 5/16-18 @90°	2 ⅞	⅞	4.60
20	S620BS 1-1/8	14½	3.333	3.667	B	1½	¼ x ⅜	(1) 5/16-18 @90°	2 ⅞	⅞	4.60
20	S620BS 1-3/16	14½	3.333	3.667	B	1⅞	¼ x ⅜	(1) 5/16-18 @90°	2 ⅞	⅞	4.60
20	S620BS 1-1/4	14½	3.333	3.667	B	1¼	¼ x ⅜	(1) 5/16-18 @90°	2 ⅞	⅞	4.60

Los engranes con ángulo de presión de 14½° no operan con engranes con ángulo de presión de 20°.

8 DP Cara 1¼"

Engranos Rectos de Acero en Existencia

Ángulo de Presión de 14½°

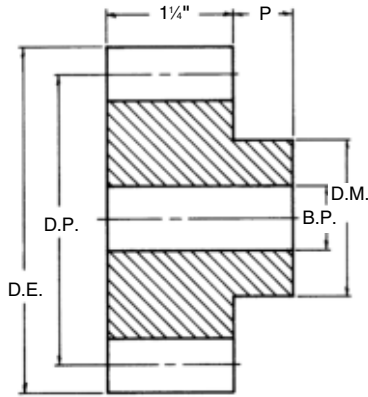
Tipo B



Tipo B
Sencillo con Maza

Acero

Número de Dientes	Número de Parte	Ángulo de Presión	Diámetro		Tipo	Barreno (Pulg.)		Maza (Pulg.)		Peso Aprox. (lb)
			Paso	Exterior		Piloto	Máx.*	Diámetro	Proy.	
11	S811	14½	1.500†	1.750	B	¾	**	1½	¾	.5
12	S812	14½	1.500	1.750	B	¾	**	1½	¾	.5
13	S813	14½	1.625	1.875	B	¾	**	1½	¾	.7
14	S814	14½	1.750	2.000	B	¾	19/16	1½	¾	.9
15	S815	14½	1.875	2.125	B	7/8	7/8	1½	¾	.9
16	S816	14½	2.000	2.250	B	7/8	19/16	1½	¾	1.1
17	S817	14½	2.125	2.375	B	7/8	1	1½	¾	1.3
18	S818	14½	2.250	2.500	B	7/8	1½	1½	¾	1.6
19	S819	14½	2.375	2.625	B	7/8	1¼	2	¾	1.8
20	S820	14½	2.500	2.750	B	7/8	19/16	2½	¾	2.0
21	S821	14½	2.625	2.875	B	7/8	17/16	2¼	¾	2.3
22	S822	14½	2.750	3.000	B	7/8	1½	2½	¾	2.6
24	S824	14½	3.000	3.250	B	7/8	1½	2½	1	3.6
26	S826	14½	3.250	3.500	B	7/8	1½	2½	1	3.9
28	S828	14½	3.500	3.750	B	7/8	1½	2½	1	4.4
30	S830	14½	3.750	4.000	B	7/8	1½	2½	1	5.1
32	S832	14½	4.000	4.250	B	1	19/16	27/16	1	5.6
36	S836	14½	4.500	4.750	B	1	1½	3	1	7.0
40	S840	14½	5.000	5.250	B	1	1½	3	1	8.3
42	S842	14½	5.250	5.500	B	1	1½	3	1	9.0
44	S844	14½	5.500	5.750	B	1	1½	3	1	9.7
48	S848	14½	6.000	6.250	B	1	1½	3	1	11.3

Los engranes con ángulo de presión de 14½° no operan con engranes con ángulo de presión de 20°.

* Barreno máximo recomendado con cuñero y opresor.

** Consulte a *Martin*.

† Diámetro de paso alargado con forma especial del diente.

Martin

Engranos Rectos de Hierro Fundido en Existencia

Ángulo de Presión de 14½°

8 DP Cara 1¼"



Tipo B Sencillo con Maza



Tipo B₁ Con Alma



Tipo B₂
Con Alma y Barrenos de Aligeramiento



Tipo B₃
Con Alma y Rayos

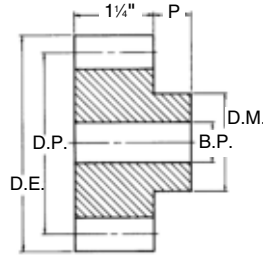

Tipo B

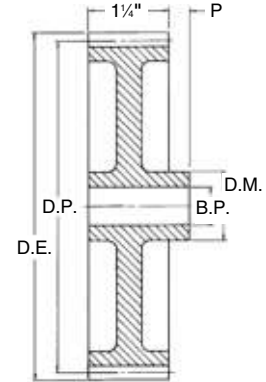

Tipo B₁, B₂, B₃

Hierro Fundido — Estilo "B"

Número de Dientes	Número de Parte	Ángulo de Presión	Diámetro		Tipo	Barreno (Pulg.)		Maza (Pulg.)		Peso Aprox. (lb)
			Paso	Exterior		Piloto	Máx.*	Diámetro	Proy.	
• 36	C836	14½	4.500	4.750	B ₁	1	1⅞	2½	1	4.5
• 40	C840	14½	5.000	5.250	B ₁	1	1⅞	2½	1	5.1
• 42	C842	14½	5.250	5.500	B ₁	1	1⅞	2½	1	5.5
• 44	C844	14½	5.500	5.750	B ₁	1	1⅞	2½	1	6.0
52	C852	14½	6.500	6.750	B ₁	1	1⅞	2½	1	10.3
54	C854	14½	6.750	7.000	B ₂	1	1⅞	2½	1	8.1
56	C856	14½	7.000	7.250	B ₃	1	1⅞	2½	1	8.2
60	C860	14½	7.500	7.750	B ₃	1	1⅞	2½	1	8.8
64	C864	14½	8.000	8.250	B ₃	1	1⅞	2½	1	11.2
68	C868	14½	8.500	8.750	B ₃	1	1⅞	3	1	11.5
72	C872	14½	9.000	9.250	B ₃	1	1⅞	3	1	11.7
76	C876	14½	9.500	9.750	B ₃	1	1⅞	3	1	12.0
80	C880	14½	10.000	10.250	B ₃	1½	1⅞	3	1½	12.2
84	C884	14½	10.500	10.750	B ₃	1½	1⅞	3	1½	13.2
88	C888	14½	11.000	11.250	B ₃	1½	1⅞	3	1½	13.5
92	C892	14½	11.500	11.750	B ₃	1½	2⅞	3½	1½	15.0
96	C896	14½	12.000	12.250	B ₃	1½	2⅞	3½	1½	15.8
100	C8100	14½	12.500	12.750	B ₃	1½	2⅞	3½	1½	16.5
112	C8112	14½	14.000	14.250	B ₃	1½	2⅞	3½	1½	17.7
120	C8120	14½	15.000	15.250	B ₃	1½	2⅞	3½	1½	18.4
128	C8128	14½	16.000	16.250	B ₃	1½	2⅞	3½	1½	21.3
144	C8144	14½	18.000	18.250	B ₃	1½	2⅞	3½	1½	24.2
160	C8160	14½	20.000	20.250	B ₃	1½	2⅞	3½	1½	26.6
168	C8168	14½	21.000	21.250	B ₃	1½	2⅞	3½	1½	28.9

* Barreno máximo recomendado con cuñero y opresor.

• Consulte a *Martin*.

Barreno a la Medida

Número de Dientes	Número de Parte	Ángulo de Presión	Diámetro		Tipo	Barreno (Pulg.)		Opresor	Maza (Pulg.)		Peso Aprox. (lb)
			Paso	Exterior		Piloto	Cuñero		Diámetro	Proy.	
11	S811BS 3/4	14½	1.500	1.750	B	¾	¾ × ⅜	(1) 10-24 @90°	1½	¾	0.50
12	S812BS 3/4	14½	1.500	1.750	B	¾	¾ × ⅜	(1) 10-24 @90°	1½	¾	0.50
14	S814BS 3/4	14½	1.750	2.000	B	¾	¾ × ⅜	(1) 1/4-20 @90°	1½	¾	0.90
15	S815BS 7/8	14½	1.875	2.125	B	7/8	¾ × ⅜	(1) 1/4-20 @90°	1½	¾	1.00
16	S816BS 7/8	14½	2.000	2.250	B	7/8	¾ × ⅜	(1) 1/4-20 @90°	1½	¾	1.10
16	S816BS 1	14½	2.000	2.250	B	1	¾ × ⅜	(1) 5/16-18 @90°	1½	¾	1.10
18	S818BS 7/8	14½	2.250	2.500	B	7/8	¾ × ⅜	(1) 1/4-20 @90°	1½	¾	1.60
18	S818BS 1	14½	2.250	2.500	B	1	¾ × ⅜	(1) 5/16-18 @90°	1½	¾	1.60
18	S818BS 1-1/8	14½	2.250	2.500	B	1½	¾ × ⅜	(1) 5/16-18 @90°	1½	¾	1.60
20	S820BS 7/8	14½	2.500	2.750	B	7/8	¾ × ⅜	(1) 1/4-20 @90°	2½	¾	2.00
20	S820BS 1	14½	2.500	2.750	B	1	¾ × ⅜	(1) 5/16-18 @90°	2½	¾	2.00
20	S820BS 1-1/8	14½	2.500	2.750	B	1½	¾ × ⅜	(1) 5/16-18 @90°	2½	¾	2.00
22	S822BS 7/8	14½	2.750	3.000	B	7/8	¾ × ⅜	(1) 1/4-20 @90°	2½	¾	2.60
22	S822BS 1	14½	2.750	3.000	B	1	¾ × ⅜	(1) 5/16-18 @90°	2½	¾	2.60
22	S822BS 1-1/8	14½	2.750	3.000	B	1½	¾ × ⅜	(1) 5/16-18 @90°	2½	¾	2.60

Los engranes con ángulo de presión de 14½° no operan con engranes con ángulo de presión de 20°.

10 DP Cara 1"

Engranos Rectos de Acero en Existencia

Ángulo de Presión de 14½°

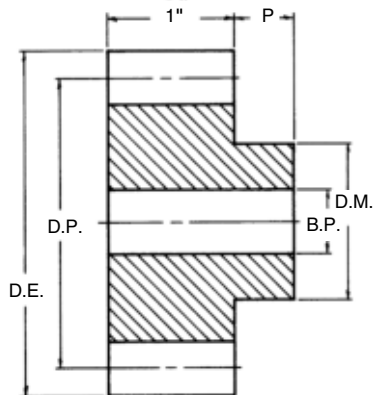

Tipo B



Tipo B
Sencillo con Maza

Acero

Número de Dientes	Número de Parte	Ángulo de Presión	Diámetro		Tipo	Barreno (Pulg.)		Maza (Pulg.)		Peso Aprox. (lb)
			Paso	Exterior		Piloto	Máx.*	Diámetro	Proy.	
11	S1011	14½	1.200 †	1.400	B	¾	**	15/16	¾	.3
12	S1012	14½	1.200	1.400	B	¾	**	15/16	¾	.3
13	S1013	14½	1.300	1.500	B	¾	**	1	¾	.3
14	S1014	14½	1.400	1.600	B	¾	¾	1 1/8	¾	.4
15	S1015	14½	1.500	1.700	B	¾	¾	1 1/2	¾	.5
16	S1016	14½	1.600	1.800	B	¾	¾	1 5/8	¾	.6
17	S1017	14½	1.700	1.900	B	¾	13/16	1 ¾	¾	.6
18	S1018	14½	1.800	2.000	B	¾	7/8	1 7/8	¾	.8
19	S1019	14½	1.900	2.100	B	¾	7/8	1 1/2	¾	.9
20	S1020	14½	2.000	2.200	B	¾	1	1 23/32	¾	1.0
21	S1021	14½	2.100	2.300	B	¾	1	1 3/4	¾	1.2
22	S1022	14½	2.200	2.400	B	¾	1 1/8	1 ¾	¾	1.3
24	S1024	14½	2.400	2.600	B	¾	1 1/4	2 1/8	¾	1.6
25	S1025	14½	2.500	2.700	B	¾	1 1/2	2 1/2	¾	1.8
26	S1026	14½	2.600	2.800	B	¾	1 1/4	2 1/8	¾	1.9
28	S1028	14½	2.800	3.000	B	¾	1 1/4	2 1/8	7/8	2.3
30	S1030	14½	3.000	3.200	B	¾	1 1/4	2 1/8	7/8	2.6
32	S1032	14½	3.200	3.400	B	¾	1 1/4	2 1/8	7/8	2.9
35	S1035	14½	3.500	3.700	B	¾	1 1/8	2 1/4	7/8	3.4
36	S1036	14½	3.600	3.800	B	¾	1 1/8	2 1/4	7/8	3.5
38	S1038	14½	3.800	4.000	B	¾	1 1/8	2 1/4	7/8	3.8
40	S1040	14½	4.000	4.200	B	¾	1 1/8	2 1/4	7/8	4.1
42	S1042	14½	4.200	4.400	B	¾	1 1/8	2 1/4	7/8	4.5
45	S1045	14½	4.500	4.700	B	¾	1 1/2	2 1/2	7/8	5.3
48	S1048	14½	4.800	5.000	B	¾	1 1/2	2 1/2	7/8	5.9
50	S1050	14½	5.000	5.200	B	¾	1 1/2	2 1/2	7/8	6.4
54	S1054	14½	5.400	5.600	B	¾	1 1/2	2 1/2	7/8	7.8
55	S1055	14½	5.500	5.700	B	¾	1 1/2	2 1/2	7/8	7.9
60	S1060	14½	6.000	6.200	B	¾	1 1/2	2 1/2	7/8	8.7

Los engranes con ángulo de presión de 14½° no operan con engranes con ángulo de presión de 20°.

* Barreno máximo recomendado con cuñero y opressor.

** Consulte a *Martin*.

† Diámetro de paso alargado con forma especial del diente.

Martin

Engranos Rectos de Hierro Fundido en Existencia

Ángulo de Presión de 14½°

10 DP

Cara 1"



Tipo B
Sencillo con Maza



Tipo B₁
Con Alma



Tipo B₂
Con Alma y Barrenos de Aligeramiento



Tipo B₃
Con Alma y Rayos

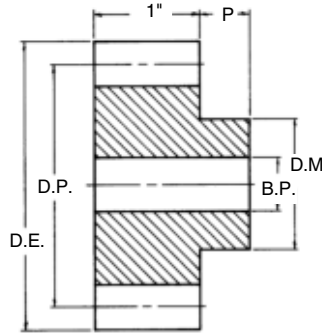

Tipo B

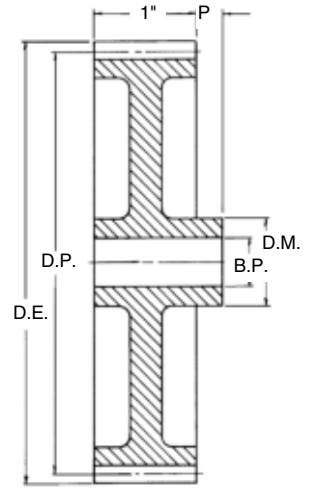

Tipo B₁, B₂, B₃

Hierro Fundido — Estilo “B”

Número de Dientes	Número de Parte	Ángulo de Presión	Diámetro		Tipo	Barreno (Pulg.)		Maza (Pulg.)		Peso Aprox. (lb)
			Paso	Exterior		Piloto	Máx.*	Diámetro	Proy.	
• 60	C1060	14½	6.000	6.200	B ₃	¾	1 ⅛	2 ½	¾	4.3
64	C1064	14½	6.400	6.600	B ₃	¾	1 ⅛	2 ½	¾	5.6
65	C1065	14½	6.500	6.700	B ₃	¾	1 ⅛	2 ½	¾	5.6
70	C1070	14½	7.000	7.200	B ₃	¾	1 ⅛	2 ½	¾	5.9
72	C1072	14½	7.200	7.500	B ₃	¾	1 ⅛	2 ½	¾	6.3
75	C1075	14½	7.500	7.700	B ₃	¾	1 ⅛	2 ½	¾	6.7
80	C1080	14½	8.000	8.200	B ₃	¾	1 ⅛	2 ½	¾	7.0
84	C1084	14½	8.400	8.600	B ₃	¾	1 ⅛	2 ½	¾	6.9
85	C1085	14½	8.500	8.700	B ₃	¾	1 ⅛	2 ½	¾	7.3
90	C1090	14½	9.000	9.200	B ₃	¾	1 ⅛	2 ½	¾	7.6
95	C1095	14½	9.500	9.700	B ₃	¾	1 ⅛	2 ½	¾	8.1
96	C1096	14½	9.600	9.800	B ₃	¾	1 ⅛	2 ½	¾	8.1
100	C10100	14½	10.000	10.200	B ₃	1	1 ⅛	2 ½	¾	10.3
105	C10105	14½	10.500	10.700	B ₃	1	1 ⅛	2 ½	1	10.4
110	C10110	14½	11.000	11.200	B ₃	1	1 ⅛	2 ½	1	10.0
112	C10112	14½	11.200	11.400	B ₃	1	1 ⅛	2 ½	1	10.2
120	C10120	14½	12.000	12.200	B ₃	1	1 ⅛	2 ½	1	11.1
130	C10130	14½	13.000	13.200	B ₃	1	1 ⅛	2 ½	1	13.4
140	C10140	14½	14.000	14.200	B ₁	1	1 ⅛	2 ½	1	30.8
150	C10150	14½	15.000	15.200	B ₁	1	1 ⅛	2 ½	1	33.0
160	C10160	14½	16.000	16.200	B ₁	1	1 ⅛	2 ½	1	38.3
180	C10180	14½	18.000	18.200	B ₃	1	1 ⅜	3	1	43.6

* Barreno máximo recomendado con cuñero y opresor.

• Consulte a *Martin*.

Barreno a la Medida

Número de Dientes	Número de Parte	Ángulo de Presión	Diámetro		Tipo	Barreno (Pulg.)		Opresor	Maza (Pulg.)		Peso Aprox. (lb)
			Paso	Exterior		Piloto	Cuñero		Diámetro	Proy.	
11	S1011BS 5/8	14½	1.200	1.400	B	5/8	¾ × ⅜	(1) 10-24 @90°	1 ⅛	5/8	0.30
12	S1012BS 5/8	14½	1.200	1.400	B	5/8	¾ × ⅜	(1) 10-24 @90°	1 ⅛	5/8	0.30
14	S1014BS 5/8	14½	1.400	1.600	B	5/8	¾ × ⅜	(1) 1/4-20 @90°	1 ⅛	5/8	0.40
15	S1015BS 3/4	14½	1.500	1.700	B	¾	¾ × ⅜	(1) 1/4-20 @90°	1 ⅜	5/8	0.50
16	S1016BS 3/4	14½	1.600	1.800	B	¾	¾ × ⅜	(1) 1/4-20 @90°	1 ⅜	5/8	0.60
18	S1018BS 3/4	14½	1.800	2.000	B	¾	¾ × ⅜	(1) 1/4-20 @90°	1 ⅜	5/8	0.80
18	S1018BS 7/8	14½	1.800	2.000	B	7/8	¾ × ⅜	(1) 1/4-20 @90°	1 ⅜	5/8	0.80
20	S1020BS 3/4	14½	2.000	2.200	B	¾	¾ × ⅜	(1) 1/4-20 @90°	1 ⅜	5/8	1.00
20	S1020BS 7/8	14½	2.000	2.200	B	7/8	¾ × ⅜	(1) 1/4-20 @90°	1 ⅜	5/8	1.00
20	S1020BS 1	14½	2.000	2.200	B	1	¾ × ⅜	(1) 5/16-18 @90°	1 ⅜	5/8	1.00
24	S1024BS 3/4	14½	2.400	2.600	B	¾	¾ × ⅜	(1) 1/4-20 @90°	2 ⅛	5/8	1.60
24	S1024BS 7/8	14½	2.400	2.600	B	7/8	¾ × ⅜	(1) 1/4-20 @90°	2 ⅛	5/8	1.60
24	S1024BS 1	14½	2.400	2.600	B	1	¾ × ⅜	(1) 5/16-18 @90°	2 ⅛	5/8	1.60

Los engranes con ángulo de presión de 14½° no operan con engranes con ángulo de presión de 20°.

12 DP

Cara $\frac{3}{4}$ "

Engranos Rectos de Acero en Existencia

Ángulo de Presión de $14\frac{1}{2}^\circ$

Martin

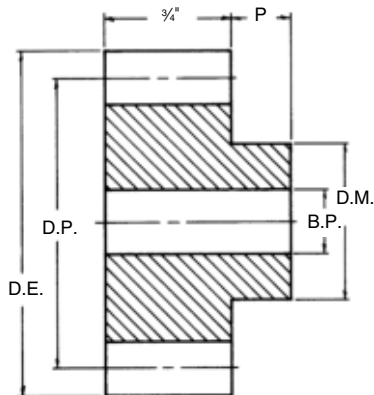

Tipo B



Tipo B
Sencillo con Maza

Acero

Número de Dientes	Número de Parte	Ángulo de Presión	Diámetro		Tipo	Barreno (Pulg.)		Maza (Pulg.)		Peso Aprox. (lb)
			Paso	Exterior		Piloto	Máx.*	Diámetro	Proy.	
11	S1211	$14\frac{1}{2}$	1.000†	1.167	B	$\frac{1}{2}$	**	$\frac{3}{4}$	$\frac{1}{2}$.14
12	S1212	$14\frac{1}{2}$	1.000	1.167	B	$\frac{1}{2}$	**	$\frac{3}{4}$	$\frac{1}{2}$.16
13	S1213	$14\frac{1}{2}$	1.083	1.250	B	$\frac{1}{2}$	**	$\frac{5}{8}$	$\frac{1}{2}$.20
14	S1214	$14\frac{1}{2}$	1.167	1.333	B	$\frac{1}{2}$	**	$\frac{7}{8}$	$\frac{1}{2}$.24
15	S1215	$14\frac{1}{2}$	1.250	1.417	B	$\frac{5}{8}$	**	1	$\frac{1}{2}$.27
16	S1216	$14\frac{1}{2}$	1.333	1.500	B	$\frac{5}{8}$	$\frac{1}{2}$	$1\frac{1}{8}$	$\frac{1}{2}$.34
17	S1217	$14\frac{1}{2}$	1.417	1.580	B	$\frac{5}{8}$	$\frac{5}{8}$	$1\frac{1}{4}$	$\frac{1}{2}$.36
18	S1218	$14\frac{1}{2}$	1.500	1.667	B	$\frac{5}{8}$	$1\frac{1}{8}$	$1\frac{1}{2}$	$\frac{1}{2}$.42
19	S1219	$14\frac{1}{2}$	1.583	1.750	B	$\frac{5}{8}$	$\frac{3}{4}$	$1\frac{5}{8}$	$\frac{1}{2}$.48
20	S1220	$14\frac{1}{2}$	1.667	1.833	B	$\frac{5}{8}$	$1\frac{1}{8}$	$1\frac{5}{8}$	$\frac{1}{2}$.56
21	S1221	$14\frac{1}{2}$	1.750	1.917	B	$\frac{5}{8}$	$\frac{7}{8}$	$1\frac{1}{2}$	$\frac{1}{2}$.64
22	S1222	$14\frac{1}{2}$	1.833	2.000	B	$\frac{5}{8}$	$\frac{7}{8}$	$1\frac{1}{8}$	$\frac{1}{2}$.70
23	S1223	$14\frac{1}{2}$	1.917	2.083	B	$\frac{5}{8}$	$1\frac{1}{8}$	$1\frac{1}{2}$	$\frac{1}{2}$.78
24	S1224	$14\frac{1}{2}$	2.000	2.166	B	$\frac{5}{8}$	1	$1\frac{3}{4}$	$\frac{1}{2}$.88
25	S1225	$14\frac{1}{2}$	2.083	2.250	B	$\frac{5}{8}$	$1\frac{1}{8}$	$1\frac{7}{8}$	$\frac{1}{2}$.96
26	S1226	$14\frac{1}{2}$	2.167	2.333	B	$\frac{5}{8}$	$1\frac{3}{8}$	$1\frac{5}{8}$	$\frac{5}{8}$	1.14
28	S1228	$14\frac{1}{2}$	2.333	2.500	B	$\frac{5}{8}$	$1\frac{1}{2}$	$2\frac{1}{8}$	$\frac{5}{8}$	1.34
30	S1230	$14\frac{1}{2}$	2.500	2.667	B	$\frac{5}{8}$	$1\frac{3}{8}$	$2\frac{1}{4}$	$\frac{5}{8}$	1.60
32	S1232	$14\frac{1}{2}$	2.667	2.833	B	$\frac{5}{8}$	$1\frac{3}{8}$	$2\frac{1}{4}$	$\frac{5}{8}$	1.72
34	S1234	$14\frac{1}{2}$	2.833	3.000	B	$\frac{5}{8}$	$1\frac{3}{8}$	$2\frac{1}{4}$	$\frac{5}{8}$	1.88
36	S1236	$14\frac{1}{2}$	3.000	3.167	B	$\frac{5}{8}$	$1\frac{1}{2}$	$2\frac{1}{2}$	$\frac{5}{8}$	2.20
38	S1238	$14\frac{1}{2}$	3.167	3.333	B	$\frac{5}{8}$	$1\frac{1}{2}$	$2\frac{1}{2}$	$\frac{5}{8}$	2.38
40	S1240	$14\frac{1}{2}$	3.333	3.500	B	$\frac{5}{8}$	$1\frac{1}{2}$	$2\frac{1}{2}$	$\frac{5}{8}$	2.54
42	S1242	$14\frac{1}{2}$	3.500	3.666	B	$\frac{5}{8}$	$1\frac{1}{2}$	$2\frac{1}{2}$	$\frac{5}{8}$	2.72
44	S1244	$14\frac{1}{2}$	3.667	3.833	B	$\frac{5}{8}$	$1\frac{1}{2}$	$2\frac{1}{2}$	$\frac{5}{8}$	2.94
48	S1248	$14\frac{1}{2}$	4.000	4.166	B	$\frac{5}{8}$	$1\frac{1}{2}$	$2\frac{1}{2}$	$\frac{3}{4}$	3.50
54	S1254	$14\frac{1}{2}$	4.500	4.666	B	$\frac{5}{8}$	$1\frac{3}{4}$	$2\frac{3}{4}$	$\frac{3}{4}$	4.40
56	S1256	$14\frac{1}{2}$	4.667	4.833	B	$\frac{5}{8}$	$1\frac{3}{4}$	$2\frac{3}{4}$	$\frac{3}{4}$	4.60
60	S1260	$14\frac{1}{2}$	5.000	5.166	B	$\frac{5}{8}$	$1\frac{3}{4}$	$2\frac{3}{4}$	$\frac{3}{4}$	5.14
64	S1264	$14\frac{1}{2}$	5.333	5.500	B	$\frac{5}{8}$	$1\frac{3}{4}$	$2\frac{3}{4}$	$\frac{3}{4}$	5.74
66	S1266	$14\frac{1}{2}$	5.500	5.666	B	$\frac{5}{8}$	$1\frac{3}{4}$	$2\frac{3}{4}$	$\frac{3}{4}$	6.02
72	S1272	$14\frac{1}{2}$	6.000	6.166	B	$\frac{5}{8}$	$1\frac{3}{4}$	$2\frac{3}{4}$	$\frac{3}{4}$	7.02

Los engranes con ángulo de presión de $14\frac{1}{2}^\circ$ no operan con engranes con ángulo de presión de 20° .

* Barreno máximo recomendado con cuñero y opresor.

• Consulte a *Martin*.

† Diámetro de paso alargado con forma especial del diente.

Martin

Engranos Rectos de Hierro Fundido en Existencia

Ángulo de Presión de 14½°

12 DP

Cara ¾"

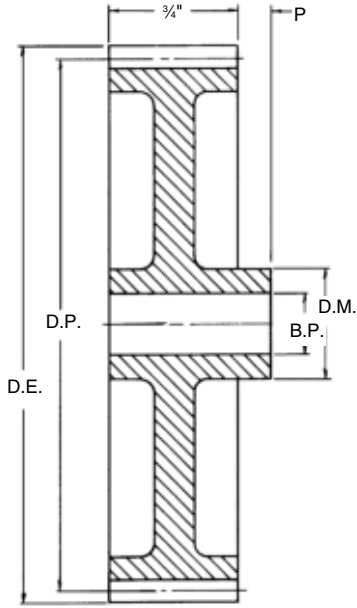

Tipo B₁, B₃



Tipo B₃
Con Alma y Rayos



Tipo B₁
Con Alma

Hierro fundido — Estilo “B”

Número de Dientes	Número de Parte	Ángulo de Presión	Diámetro		Tipo	Barreno (Pulg.)		Maza (Pulg.)		Peso Aprox. (lb)
			Paso	Exterior		Piloto	Máx.*	Diámetro	Proy.	
78	C1278	14½	6.500	6.666	B ₃	¾	1 1/16	2 ½	¾	4.1
84	C1284	14½	7.000	7.166	B ₃	¾	1 1/16	2 ½	¾	4.4
90	C1290	14½	7.500	7.666	B ₃	¾	1 1/16	2 ½	¾	5.2
96	C1296	14½	8.000	8.166	B ₃	¾	1 1/16	2 ½	¾	5.5
102	C12102	14½	8.500	8.666	B ₃	¾	1 1/16	2 ½	¾	5.9
108	C12108	14½	9.000	9.166	B ₃	¾	1 1/16	2 ½	¾	6.4
112	C12112	14½	9.333	9.500	B ₃	¾	1 1/16	2 ½	¾	6.4
114	C12114	14½	9.500	9.666	B ₃	¾	1 1/16	2 ½	¾	6.4
120	C12120	14½	10.000	10.166	B ₃	¾	1 1/16	2 ½	¾	8.1
126	C12126	14½	10.500	10.666	B ₃	¾	1 1/16	3	¾	7.4
144	C12144	14½	12.000	12.166	B ₃	¾	1 1/16	3	1	10.1
168	C12168	14½	14.000	14.166	B ₁	¾	1 1/16	3	1	10.6

* Máximo barreno recomendado con cuñero y oprobador.

Barreno a la Medida

Número de Dientes	Número de Parte	Ángulo de Presión	Diámetro		Tipo	Barreno (Pulg.)		Oprobador	Maza (Pulg.)		Peso Aprox. (lb)
			Paso	Exterior		Piloto	Cuñero		Diámetro	Proy.	
11	S1211BS 1/2	14½	1.000	1.167	B	½	NINGÚN	(1) 10-24	¾	½	0.14
12	S1212BS 1/2	14½	1.000	1.167	B	½	NINGÚN	(1) 10-24	¾	½	0.16
13	S1213BS 1/2	14½	1.083	1.250	B	½	NINGÚN	(1) 10-24	13/16	½	0.20
14	S1214BS 1/2	14½	1.167	1.333	B	½	NINGÚN	(1) 10-24	29/32	¾	0.24
15	S1215BS 5/8	14½	1.250	1.417	B	5/8	3/16 x 3/32	(1) 1/4-20 @90°	1	½	0.27
16	S1216BS 5/8	14½	1.333	1.500	B	5/8	3/16 x 3/32	(1) 1/4-20 @90°	1 1/16	½	0.34
18	S1218BS 5/8	14½	1.500	1.667	B	5/8	3/16 x 3/32	(1) 1/4-20 @90°	1 ¼	½	0.42
20	S1220BS 5/8	14½	1.667	1.833	B	5/8	3/16 x 3/32	(1) 1/4-20 @90°	1 1/2	½	0.56
20	S1220BS 3/4	14½	1.667	1.833	B	¾	3/16 x 3/32	(1) 1/4-20 @90°	1 13/32	½	0.56
21	S1221BS 5/8	14½	1.750	1.917	B	5/8	3/16 x 3/32	(1) 1/4-20 @90°	1 1/2	½	0.56
21	S1221BS 3/4	14½	1.750	1.917	B	¾	3/16 x 3/32	(1) 1/4-20 @90°	1 13/32	½	0.56
21	S1221BS 7/8	14½	1.750	1.917	B	7/8	3/16 x 3/32	(1) 1/4-20 @90°	1 13/32	½	0.56
22	S1222BS 5/8	14½	1.833	2.000	B	5/8	3/16 x 3/32	(1) 1/4-20 @90°	1 1/2	½	0.70
22	S1222BS 3/4	14½	1.833	2.000	B	¾	3/16 x 3/32	(1) 1/4-20 @90°	1 1/16	½	0.70
22	S1222BS 7/8	14½	1.833	2.000	B	7/8	3/16 x 3/32	(1) 1/4-20 @90°	1 1/16	½	0.70
22	S1222BS 1	14½	1.833	2.000	B	1	¼ x 1/8	(1) 5/16-18 @90°	1 1/16	½	0.70
24	S1224BS 5/8	14½	2.000	2.167	B	5/8	3/16 x 3/32	(1) 1/4-20 @90°	1 ¼	½	0.88
24	S1224BS 3/4	14½	2.000	2.167	B	¾	3/16 x 3/32	(1) 1/4-20 @90°	1 ¾	½	0.88
24	S1224BS 7/8	14½	2.000	2.167	B	7/8	3/16 x 3/32	(1) 1/4-20 @90°	1 ¾	½	0.88
24	S1224BS 1	14½	2.000	2.167	B	1	¼ x 1/8	(1) 5/16-18 @90°	1 ¾	½	0.88

Los engranes con ángulo de presión de 14½° no operan con engranes con ángulo de presión de 20°.

16 DP

Cara 1/2"

Engranos Rectos de Acero en Existencia

Ángulo de Presión de 14½°

Martin

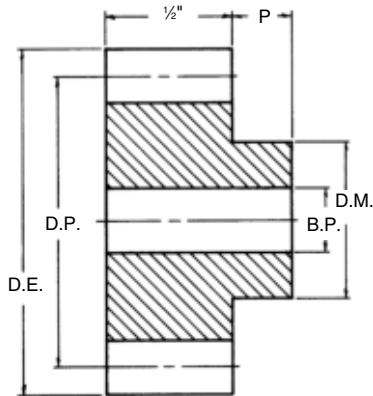

Tipo B



Tipo B
Sencillo con Maza

Acero

Número de Dientes	Número de Parte	Ángulo de Presión	Diámetro		Tipo	Barreno (Pulg.)		Maza (Pulg.)		Peso Aprox. (lb)
			Paso	Exterior		Piloto	Máx.*	Diámetro	Proy.	
11	S1611	14½	.750†	.875	B	¾	**	⅞	⅞	0.06
12	S1612	14½	.750	.875	B	¾	**	⅞	⅞	0.06
13	S1613	14½	.812	.937	B	¾	**	⅞	⅞	0.08
14	S1614	14½	.875	1.000	B	¾	**	1⅛	⅞	0.08
15	S1615	14½	.937	1.062	B	½	**	¾	⅞	0.10
16	S1616	14½	1.000	1.125	B	½	**	⅞	⅞	0.12
17	S1617	14½	1.062	1.187	B	½	**	⅞	⅞	0.14
18	S1618	14½	1.125	1.250	B	½	**	⅞	⅞	0.16
19	S1619	14½	1.187	1.312	B	½	½	1	⅞	0.20
20	S1620	14½	1.250	1.375	B	½	⅞	1⅛	⅞	0.22
21	S1621	14½	1.312	1.438	B	½	¾	1⅛	⅞	0.24
22	S1622	14½	1.375	1.500	B	½	¾	1⅛	⅞	0.28
23	S1623	14½	1.437	1.562	B	½	⅞	1¼	⅞	0.32
24	S1624	14½	1.500	1.625	B	½	¾	1⅛	⅞	0.34
26	S1626	14½	1.625	1.750	B	½	¾	1⅛	⅞	0.42
28	S1628	14½	1.750	1.875	B	½	¾	1½	½	0.52
30	S1630	14½	1.875	2.000	B	½	⅞	1⅞	½	0.60
32	S1632	14½	2.000	2.125	B	½	1	1¾	½	0.70
34	S1634	14½	2.125	2.250	B	½	1⅞	1⅞	½	0.80
36	S1636	14½	2.250	2.375	B	½	1¾	2	½	0.92
38	S1638	14½	2.375	2.500	B	½	1¼	2	½	0.98
40	S1640	14½	2.500	2.626	B	½	1¼	2	½	1.1
44	S1644	14½	2.750	2.875	B	½	1¼	2	½	1.2
48	S1648	14½	3.000	3.125	B	½	1¼	2	½	1.4
52	S1652	14½	3.250	3.375	B	½	1¼	2	½	1.5
54	S1654	14½	3.375	3.500	B	½	1¼	2	½	1.6
56	S1656	14½	3.500	3.625	B	½	1¼	2	½	1.7
60	S1660	14½	3.750	3.875	B	½	1¼	2	½	1.3
64	S1664	14½	4.000	4.125	B	¾	1¼	2	¾	2.2
68	S1668	14½	4.250	4.375	B	¾	1⅞	2¼	¾	2.5
72	S1672	14½	4.500	4.625	B	¾	1⅞	2¼	¾	2.8
80	S1680	14½	5.000	5.125	B	¾	1⅞	2¼	¾	3.4
84	S1684	14½	5.250	5.375	B	¾	1⅞	2¼	¾	3.6
88	S1688	14½	5.500	5.625	B	¾	1⅞	2¼	¾	3.9
96	S1696	14½	6.000	6.125	B	¾	1⅞	2¼	¾	4.6
104	S16104	14½	6.500	6.625	B	¾	1⅞	2¼	¾	5.2

Los engranes con ángulo de presión de 14½° no operan con engranes con ángulo de presión de 20°.

* Barreno máximo recomendado con cuñero y opressor.

** Consulte a *Martin*.

† Diámetro de paso alargado con forma especial del diente.

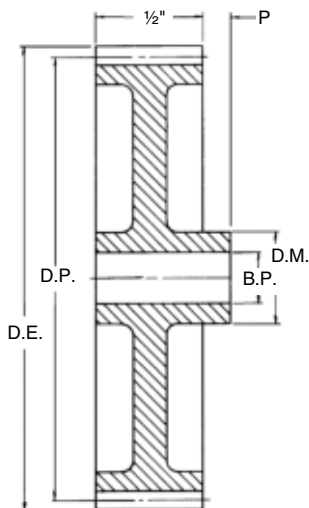

Tipo B₁, B₃



Tipo B₃
Con Alma
y Rayos



Tipo B₁
Con Alma

Hierro Fundido — Estilo “B”

Número de Dientes	Número de Parte	Ángulo de Presión	Diámetro		Tipo	Barreno (Pulg.)		Maza (Pulg.)		Peso Aprox. (lb)
			Paso	Exterior		Piloto	Máx.*	Diámetro	Proy.	
112	C16112	14½	7.000	7.125	B ₃	⅜	1⅞	2½	⅝	3.4
120	C16120	14½	7.500	7.625	B ₃	⅜	1⅞	2½	⅝	3.5
128	C16128	14½	8.000	8.125	B ₃	⅜	1⅞	2½	⅝	3.7
144	C16144	14½	9.000	9.125	B ₃	⅜	1⅞	2¾	⅝	5.0
160	C16160	14½	10.000	10.125	B ₃	⅜	1⅞	2¾	⅝	5.2
192	C16192	14½	12.000	12.125	B ₁	⅜	1⅞	2¾	⅝	8.1

* Barreno máximo recomendado con cuñero y opresor.

• Consulte a *Martin*.

Barreno a la Medida

Número de Dientes	Número de Parte	Ángulo de Presión	Diámetro		Tipo	Barreno (Pulg.)		Opresor	Maza (Pulg.)		Peso Aprox. (lb)
			Paso	Exterior		Piloto	Cuñero		Diámetro	Proy.	
11	S1611BS 3/8	14½	0.750	0.875	B	⅜	NINGÚN	(1) 8-32	⅜	⅞	0.06
12	S1612BS 3/8	14½	0.752	0.875	B	⅜	NINGÚN	(1) 8-32	⅜	⅞	0.06
13	S1613BS 3/8	14½	0.812	0.937	B	⅜	NINGÚN	(1) 8-32	⅜	⅞	0.08
14	S1614BS 3/8	14½	0.875	1.000	B	⅜	NINGÚN	(1) 10-24	1⅞	⅞	0.08
15	S1615BS 1/2	14½	0.937	1.062	B	½	NINGÚN	(1) 10-24	¾	⅞	0.10
16	S1616BS 1/2	14½	1.000	1.125	B	½	NINGÚN	(1) 10-24	1⅞	⅞	0.12
18	S1618BS 1/2	14½	1.125	1.250	B	½	NINGÚN	(1) 1/4-20	1⅞	⅞	0.16
20	S1620BS 1/2	14½	1.250	1.375	B	½	NINGÚN	(1) 1/4-20	1⅞	⅞	0.22
20	S1620BS 5/8	14½	1.250	1.375	B	⅝	⅜ x ⅜ ₃₂	(1) 1/4-20 @90°	1⅞	⅞	0.22
22	S1622BS 1/2	14½	1.375	1.500	B	½	NINGÚN	(1) 1/4-20	1⅞	⅞	0.28
22	S1622BS 5/8	14½	1.375	1.500	B	⅝	⅜ x ⅜ ₃₂	(1) 1/4-20 @90°	1⅞	⅞	0.28
24	S1624BS 1/2	14½	1.500	1.625	B	½	NINGÚN	(1) 1/4-20	1⅞	⅞	0.34
24	S1624BS 5/8	14½	1.500	1.625	B	⅝	⅜ x ⅜ ₃₂	(1) 1/4-20 @90°	1⅞	⅞	0.34
24	S1624BS 3/4	14½	1.500	1.625	B	¾	⅜ x ⅜ ₃₂	(1) 1/4-20 @90°	1⅞	⅞	0.34
26	S1626BS 1/2	14½	1.625	1.750	B	½	NINGÚN	(1) 1/4-20	1⅞	⅞	0.42
26	S1626BS 5/8	14½	1.625	1.750	B	⅝	⅜ x ⅜ ₃₂	(1) 1/4-20 @90°	1⅞	⅞	0.42
26	S1626BS 3/4	14½	1.625	1.750	B	¾	⅜ x ⅜ ₃₂	(1) 1/4-20 @90°	1⅞	⅞	0.42
28	S1628BS 1/2	14½	1.750	1.875	B	½	NINGÚN	(1) 1/4-20	1½	½	0.52
28	S1628BS 5/8	14½	1.750	1.875	B	⅝	⅜ x ⅜ ₃₂	(1) 1/4-20 @90°	1½	½	0.52
28	S1628BS 3/4	14½	1.750	1.875	B	¾	⅜ x ⅜ ₃₂	(1) 1/4-20 @90°	1½	½	0.52
28	S1628BS 7/8	14½	1.750	1.875	B	⅞	⅜ x ⅜ ₃₂	(1) 1/4-20 @90°	1½	½	0.52
30	S1630BS 1/2	14½	1.875	2.000	B	½	NINGÚN	(1) 1/4-20	1⅞	⅞	0.60
30	S1630BS 5/8	14½	1.875	2.000	B	⅝	⅜ x ⅜ ₃₂	(1) 1/4-20 @90°	1⅞	⅞	0.60
30	S1630BS 3/4	14½	1.875	2.000	B	¾	⅜ x ⅜ ₃₂	(1) 1/4-20 @90°	1⅞	⅞	0.60
30	S1630BS 7/8	14½	1.875	2.000	B	⅞	⅜ x ⅜ ₃₂	(1) 1/4-20 @90°	1⅞	⅞	0.60
30	S1630BS 1	14½	1.875	2.000	B	1	¼ x 1/8	(1) 5/16-18 @90°	1⅞	⅞	0.60
32	S1632BS 1/2	14½	2.000	2.125	B	½	NINGÚN	(1) 1/4-20	1¾	½	0.70
32	S1632BS 5/8	14½	2.000	2.125	B	⅝	⅜ x ⅜ ₃₂	(1) 1/4-20 @90°	1¾	½	0.70
32	S1632BS 3/4	14½	2.000	2.125	B	¾	⅜ x ⅜ ₃₂	(1) 1/4-20 @90°	1¾	½	0.70
32	S1632BS 7/8	14½	2.000	2.125	B	⅞	⅜ x ⅜ ₃₂	(1) 1/4-20 @90°	1¾	½	0.70
32	S1632BS 1	14½	2.000	2.125	B	1	¼ x 1/8	(1) 5/16-18 @90°	1¾	½	0.70

Los engranes con ángulo de presión de 14½° no operan con engranes con ángulo de presión de 20°.

20 DP

Cara $\frac{3}{8}$ "

Engranos Rectos de Acero en Existencia

Ángulo de Presión de $14\frac{1}{2}^\circ$

Martin

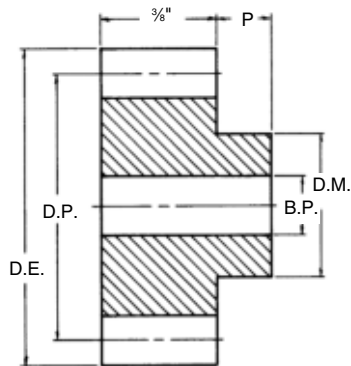

Tipo B



Tipo B
Sencillo con Maza

Acero

Número de Dientes	Número de Parte	Ángulo de Presión	Diámetro		Tipo	Barreno (Pulg.)		Maza (Pulg.)		Peso Aprox. (lb)
			Paso	Exterior		Piloto	Máx.*	Diámetro	Proy.	
11	S2011	$14\frac{1}{2}$.600†	.700	B	$\frac{5}{16}$	**	$\frac{15}{32}$	$\frac{3}{8}$.02
12	S2012	$14\frac{1}{2}$.600	.700	B	$\frac{5}{16}$	**	$\frac{15}{32}$	$\frac{3}{8}$.02
13	S2013	$14\frac{1}{2}$.650	.750	B	$\frac{1}{2}$	**	$\frac{1}{2}$	$\frac{3}{8}$.04
14	S2014	$14\frac{1}{2}$.700	.800	B	$\frac{5}{16}$	**	$\frac{35}{64}$	$\frac{3}{8}$.04
15	S2015	$14\frac{1}{2}$.750	.850	B	$\frac{3}{8}$	**	$\frac{39}{64}$	$\frac{3}{8}$.04
16	S2016	$14\frac{1}{2}$.800	.900	B	$\frac{3}{8}$	**	$\frac{21}{32}$	$\frac{3}{8}$.04
17	S2017	$14\frac{1}{2}$.850	.950	B	$\frac{3}{8}$	**	$\frac{45}{64}$	$\frac{3}{8}$.08
18	S2018	$14\frac{1}{2}$.900	1.000	B	$\frac{3}{8}$	**	$\frac{3}{4}$	$\frac{3}{8}$.08
19	S2019	$14\frac{1}{2}$.950	1.050	B	$\frac{3}{8}$	**	$\frac{51}{64}$	$\frac{3}{8}$.10
20	S2020	$14\frac{1}{2}$	1.000	1.100	B	$\frac{3}{8}$	**	$\frac{55}{64}$	$\frac{3}{8}$.12
21	S2021	$14\frac{1}{2}$	1.050	1.150	B	$\frac{3}{8}$	**	$\frac{7}{8}$	$\frac{3}{8}$.12
22	S2022	$14\frac{1}{2}$	1.100	1.200	B	$\frac{3}{8}$	**	$\frac{31}{32}$	$\frac{3}{8}$.14
23	S2023	$14\frac{1}{2}$	1.150	1.250	B	$\frac{3}{8}$	**	$\frac{31}{32}$	$\frac{3}{8}$.16
24	S2024	$14\frac{1}{2}$	1.200	1.300	B	$\frac{3}{8}$	$\frac{9}{16}$	$1\frac{1}{16}$	$\frac{3}{8}$.19
25	S2025	$14\frac{1}{2}$	1.250	1.350	B	$\frac{3}{8}$	$\frac{3}{8}$	$1\frac{1}{64}$	$\frac{3}{8}$.20
28	S2028	$14\frac{1}{2}$	1.400	1.500	B	$\frac{3}{8}$	$1\frac{1}{16}$	$1\frac{13}{64}$	$\frac{3}{8}$.26
30	S2030	$14\frac{1}{2}$	1.500	1.600	B	$\frac{3}{8}$	$\frac{19}{32}$	$1\frac{29}{64}$	$\frac{3}{8}$.30
32	S2032	$14\frac{1}{2}$	1.600	1.700	B	$\frac{3}{8}$	$\frac{7}{8}$	$1\frac{1}{16}$	$\frac{1}{2}$.40
35	S2035	$14\frac{1}{2}$	1.750	1.850	B	$\frac{3}{8}$	$\frac{7}{8}$	$1\frac{1}{16}$	$\frac{1}{2}$.50
36	S2036	$14\frac{1}{2}$	1.800	1.900	B	$\frac{3}{8}$	$\frac{19}{32}$	$1\frac{3}{8}$	$\frac{1}{2}$.52
40	S2040	$14\frac{1}{2}$	2.000	2.100	B	$\frac{3}{8}$	$1\frac{1}{16}$	$1\frac{13}{16}$	$\frac{1}{2}$.64
45	S2045	$14\frac{1}{2}$	2.250	2.350	B	$\frac{3}{8}$	$1\frac{1}{4}$	2	$\frac{1}{2}$.82
48	S2048	$14\frac{1}{2}$	2.400	2.500	B	$\frac{3}{8}$	$1\frac{1}{4}$	2	$\frac{1}{2}$.88
50	S2050	$14\frac{1}{2}$	2.500	2.600	B	$\frac{3}{8}$	$1\frac{1}{4}$	2	$\frac{1}{2}$.90
55	S2055	$14\frac{1}{2}$	2.750	2.850	B	$\frac{3}{8}$	$1\frac{1}{4}$	2	$\frac{1}{2}$	1.04
60	S2060	$14\frac{1}{2}$	3.000	3.100	B	$\frac{3}{8}$	$1\frac{1}{4}$	2	$\frac{1}{2}$	1.16
64	S2064	$14\frac{1}{2}$	3.200	3.300	B	$\frac{3}{8}$	$1\frac{1}{4}$	2	$\frac{1}{2}$	1.26
70	S2070	$14\frac{1}{2}$	3.500	3.600	B	$\frac{3}{8}$	$1\frac{1}{4}$	2	$\frac{1}{2}$	1.40
72	S2072	$14\frac{1}{2}$	3.600	3.700	B	$\frac{3}{8}$	$1\frac{1}{8}$	$2\frac{1}{4}$	$\frac{1}{2}$	1.60
75	S2075	$14\frac{1}{2}$	3.750	3.850	B	$\frac{3}{8}$	$1\frac{1}{8}$	$2\frac{1}{4}$	$\frac{1}{2}$	1.70
80	S2080	$14\frac{1}{2}$	4.000	4.100	B	$\frac{1}{2}$	$1\frac{1}{8}$	$2\frac{1}{4}$	$\frac{1}{2}$	1.82
84	S2084	$14\frac{1}{2}$	4.200	4.300	B	$\frac{1}{2}$	$1\frac{1}{8}$	$2\frac{1}{4}$	$\frac{1}{2}$	1.96
90	S2090	$14\frac{1}{2}$	4.500	4.600	B	$\frac{1}{2}$	$1\frac{1}{8}$	$2\frac{1}{4}$	$\frac{1}{2}$	2.20
96	S2096	$14\frac{1}{2}$	4.800	4.900	B	$\frac{1}{2}$	$1\frac{1}{8}$	$2\frac{1}{4}$	$\frac{1}{2}$	2.42
100	S2100	$14\frac{1}{2}$	5.000	5.100	B	$\frac{1}{2}$	$1\frac{1}{8}$	$2\frac{1}{4}$	$\frac{1}{2}$	2.60
112	S2112	$14\frac{1}{2}$	5.600	5.700	B	$\frac{1}{2}$	1	1 $\frac{1}{4}$	$\frac{1}{2}$	2.86
120	S20120	$14\frac{1}{2}$	6.000	6.100	B ₁	$\frac{1}{2}$	1	1 $\frac{3}{4}$	$\frac{1}{2}$	3.24
132	S20132	$14\frac{1}{2}$	6.600	6.700	B	$\frac{1}{2}$	1	1 $\frac{3}{4}$	$\frac{1}{2}$	3.80

Los engranes con ángulo de presión de $14\frac{1}{2}^\circ$ no operan con engranes con ángulo de presión de 20° .

* Barreno máximo recomendado con cuñero y opresor.

** Consulte a *Martin*.

† Diámetro de paso alargado con forma especial del diente.

Martin

Engranos Rectos de Hierro Fundido en Existencia

Ángulo de Presión de 14½°

20 DP

Cara 3/8"

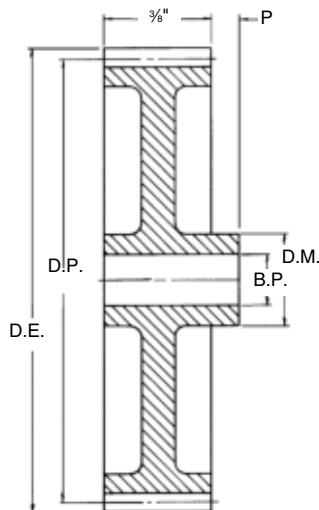

Tipo B₃
Con Alma
y Rayos



Tipo B₁
Con Alma

Tipo B₁, B₃

Hierro Fundido — Estilo “B”

Número de Dientes	Número de Parte	Ángulo de Presión	Diámetro		Tipo	Barreno (Pulg.)		Maza (Pulg.)		Peso Aprox. (lb)
			Paso	Exterior		Piloto	Máx.*	Diámetro	Proy.	
•48	C2048	14½	2.400	2.500	B ₁	3/8	5/16	1 1/8	1/2	.50
•64	C2064	14½	3.200	3.300	B ₁	3/8	5/16	1 1/8	1/2	.68
140	C20140	14½	7.000	7.100	B ₁	1/2	1	1 3/4	1/2	2.00
160	C20160	14½	8.000	8.100	B ₁	1/2	1	1 3/4	3/4	2.34
180	C20180	14½	9.000	9.100	B ₁	1/2	1	1 3/4	3/4	2.66
200	C20200	14½	10.000	10.100	B ₁	1/2	1	1 3/4	3/4	2.84

* Barreno máximo recomendado con cuñero y opresor.

• Consulte a *Martin*.

Barreno a la Medida

Número de Dientes	Número de Parte	Ángulo de Presión	Diámetro		Tipo	Barreno (Pulg.)		Opresor	Maza (Pulg.)		Peso Aprox. (lb)
			Paso	Exterior		Piloto	Cuñero		Diámetro	Proy.	
11	S2011BS 5/16	14½	0.600	0.700	B	5/16	NINGÚN	#35 P.H.	15/32	3/8	0.02
12	S2012BS 3/8	14½	0.600	0.700	B	5/16	NINGÚN	#35 P.H.	15/32	3/8	0.02
13	S2013BS 5/16	14½	0.650	0.750	B	5/16	NINGÚN	#35 P.H.	1/2	3/8	0.04
14	S2014BS 5/16	14½	0.700	0.800	B	5/16	NINGÚN	#35 P.H.	3/8	3/8	0.04
15	S2015BS 3/8	14½	0.750	0.850	B	3/8	NINGÚN	(1) 8-32	39/64	3/8	0.04
16	S2016BS 3/8	14½	1.800	0.900	B	3/8	NINGÚN	(1) 8-32	21/32	3/8	0.04
18	S2018BS 3/8	14½	1.900	1.000	B	3/8	NINGÚN	(1) 10-24	3/4	3/8	0.08
20	S2020BS 3/8	14½	1.000	1.100	B	3/8	NINGÚN	(1) 10-24	55/64	3/8	0.12
20	S2020BS 1/2	14½	1.000	1.100	B	1/2	NINGÚN	(1) 10-24	55/64	3/8	0.12
22	S2022BS 3/8	14½	1.100	1.200	B	3/8	NINGÚN	(1) 1/4-20	31/32	3/8	0.14
22	S2022BS 1/2	14½	1.100	1.200	B	1/2	NINGÚN	(1) 1/4-20	31/32	3/8	0.14
24	S2024BS 3/8	14½	1.200	1.300	B	3/8	NINGÚN	(1) 1/4-20	1 1/8	3/8	0.19
24	S2024BS 1/2	14½	1.200	1.300	B	1/2	NINGÚN	(1) 1/4-20	1 1/8	3/8	0.19
25	S2025BS 3/8	14½	1.250	1.350	B	3/8	NINGÚN	(1) 1/4-20	1 1/8	3/8	0.20
25	S2025BS 1/2	14½	1.250	1.350	B	1/2	NINGÚN	(1) 1/4-20	1 1/8	3/8	0.20
28	S2028BS 3/8	14½	1.400	1.500	B	3/8	NINGÚN	(1) 1/4-20	1 1/8	3/8	0.26
28	S2028BS 1/2	14½	1.400	1.500	B	1/2	NINGÚN	(1) 1/4-20	1 1/8	3/8	0.26
30	S2030BS 3/8	14½	1.500	1.600	B	3/8	NINGÚN	(1) 1/4-20	1 23/64	3/8	0.30
30	S2030BS 1/2	14½	1.500	1.600	B	1/2	NINGÚN	(1) 1/4-20	1 23/64	3/8	0.30
32	S2032BS 3/8	14½	1.600	1.700	B	3/8	NINGÚN	(1) 1/4-20	1 1/8	1/2	0.40
32	S2032BS 1/2	14½	1.600	1.700	B	1/2	NINGÚN	(1) 1/4-20	1 1/8	1/2	0.40
35	S2035BS 3/8	14½	1.750	1.850	B	3/8	NINGÚN	(1) 1/4-20	1 1/8	1/2	0.50
35	S2035BS 1/2	14½	1.750	1.850	B	1/2	NINGÚN	(1) 1/4-20	1 1/8	1/2	0.50
36	S2036BS 3/8	14½	1.800	1.900	B	3/8	NINGÚN	(1) 1/4-20	1 5/8	1/2	0.52
36	S2036BS 1/2	14½	1.800	1.900	B	1/2	NINGÚN	(1) 1/4-20	1 5/8	1/2	0.52
40	S2040BS 3/8	14½	2.000	2.100	B	3/8	NINGÚN	(1) 1/4-20	1 13/16	1/2	0.64
40	S2040BS 1/2	14½	2.000	2.100	B	1/2	NINGÚN	(1) 1/4-20	1 13/16	1/2	0.64
40	S2040BS 5/8	14½	2.000	2.100	B	5/8	3/16 x 3/32	(1) 1/4-20 @ 90°	1 13/16	1/2	0.64
40	S2040BS 3/4	14½	2.000	2.100	B	3/4	3/16 x 3/32	(1) 1/4-20 @ 90°	1 13/16	1/2	0.64

Los engranes con ángulo de presión de 14½° no operan con engranes con ángulo de presión de 20°.

24 DP

Cara 1/4"

Engranos Rectos de Acero en Existencia

Ángulo de Presión de 14½°

Martin

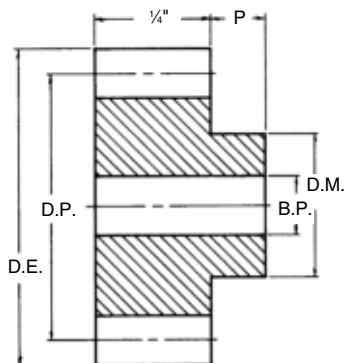

Tipo B



Tipo B
Sencillo con Maza

Acero

Número de Dientes	Número de Parte	Ángulo de Presión	Diámetro		Tipo	Barreno (Pulg.)		Maza (Pulg.)		Peso Aprox. (lb)
			Paso	Exterior		Piloto	Máx.*	Diámetro	Proy.	
11	S2411	14½	.500†	.583	B	¼	**	¾	⅜	.02
12	S2412	14½	.500	.583	B	¼	**	¾	⅜	.02
14	S2414	14½	.583	.666	B	¼	**	15/32	⅜	.04
15	S2415	14½	.625	.708	B	¼	**	½	⅜	.04
16	S2416	14½	.666	.750	B	⅜	**	5/8	⅜	.04
17	S2417	14½	.709	.791	B	⅜	**	⅜	⅜	.04
18	S2418	14½	.750	.833	B	⅜	**	⅜	⅜	.04
19	S2419	14½	.791	.875	B	⅜	**	⅜	⅜	.06
20	S2420	14½	.833	.917	B	⅜	**	23/32	⅜	.06
21	S2421	14½	.875	.959	B	¾	**	¾	⅜	.06
22	S2422	14½	.917	1.000	B	¾	**	¾	⅜	.06
24	S2424	14½	1.000	1.083	B	¾	**	¾	⅜	.10
26	S2426	14½	1.083	1.166	B	¾	**	7/8	⅜	.10
27	S2427	14½	1.125	1.208	B	¾	**	7/8	⅜	.12
30	S2430	14½	1.250	1.333	B	¾	½	1	⅜	.16
32	S2432	14½	1.333	1.416	B	¾	½	1	⅜	.20
33	S2433	14½	1.375	1.458	B	¾	⅝	1 1/8	⅜	.20
36	S2436	14½	1.500	1.583	B	¾	⅝	1 1/8	⅜	.20
40	S2440	14½	1.666	1.750	B	¾	⅝	1 1/8	⅜	.24
42	S2442	14½	1.750	1.833	B	¾	1 1/16	1 1/4	⅜	.28
44	S2444	14½	1.833	1.917	B	¾	1 1/16	1 1/4	⅜	.30
45	S2445	14½	1.875	1.959	B	¾	1 1/16	1 1/4	⅜	.30
48	S2448	14½	2.000	2.083	B	¾	1 1/16	1 1/4	⅜	.32
54	S2454	14½	2.250	2.333	B	¾	1 1/16	1 1/4	⅜	.38
56	S2456	14½	2.333	2.416	B	¾	1 1/16	1 1/4	⅜	.40
60	S2460	14½	2.500	2.583	B	¾	1 1/16	1 1/4	⅜	.46
66	S2466	14½	2.750	2.833	B	¾	1 1/16	1 1/4	⅜	.52
72	S2472	14½	3.000	3.083	B	½	1 3/16	1 3/8	½	.64
84	S2484	14½	3.500	3.583	B	½	7/8	1 1/2	½	.88
96	S2496	14½	4.000	4.083	B	½	7/8	1 1/2	½	1.08
120	S24120	14½	5.000	5.083	B	½	7/8	1 1/2	½	2.60
144	S24144	14½	6.000	6.083	B	½	1 1/16	1 1/2	1 1/32	2.28

Los engranes con ángulo de presión de 14½° no operan con engranes con ángulo de presión de 20°.

* Barreno máximo recomendado con cuñero y opresor.

** Consulte a *Martin*.

† Diámetro de paso alargado con forma especial del diente.



Capacidad de Potencia HP de Engranés Rectos

Ángulo de Presión de 14½°

(S) = Acero (CI) = Hierro Fundido

3 DP — Cara de 3"

Número de Dientes	50 RPM		100 RPM		200 RPM		300 RPM		600 RPM		900 RPM		1200 RPM		1800 RPM	
	S	CI	S	CI	S	CI	S	CI	S	CI	S	CI	S	CI	S	CI
12	6.14		11.37		19.8		26.3		39.14		46.74		51.78			
15	8.76		15.96		27.06		35.24		50.49		59.01					
18	11.37		20.38		33.75		43.2		60		68.93					
21	13.92		24.59		39.84		50.24		67.96							
24	16.32	9.67	28.53	16.84	45.16	26.76	56.19	33.3	74.34	44.05						
48	32.28	19.5	51.3	30.98	72.69	43.9	84.44	51.39								
72	45.01	27.06	66.98	40.29	88.62	53.32										
96	54.74	32.95	77.57	46.7	98.01	59.01										
120	62.89	37.74	85.79	51.48	104.88	62.93										

4 DP Cara de 2"

Número de Dientes	50 RPM		100 RPM		200 RPM		300 RPM		600 RPM		900 RPM		1200 RPM		1800 RPM	
	S	CI	S	CI	S	CI	S	CI	S	CI	S	CI	S	CI	S	CI
12	2.35		4.42		7.92		10.77		16.8		20.65		23.33		27	
16	3.81		6.85		11.92		15.82		23.6		28.18		31.23			
20	5.06		9.22		15.65		20.38		29.19		31.11					
24	6.27	3.77	11.25	6.75	18.64	11.19	23.86	14.32	33.14	19.88	38.17	22.84				
36	10.03	5.96	17.23	10.24	28.01	15.98	33.05	16.94	42.89	25.49						
48	12.94	7.82	21.44	12.95	31.91	19.28	38.12	23.02	47.31	28.58						
72		11.1		17.32		24.05		27.65								
96		13.78		20.5		27.12										
144		18		25		31										

5 DP Cara de 1¾"

Número de Dientes	50 RPM		100 RPM		200 RPM		300 RPM		600 RPM		900 RPM		1200 RPM		1800 RPM	
	S	CI	S	CI	S	CI	S	CI	S	CI	S	CI	S	CI	S	CI
12	1.32		2.54		4.63		6.4		10.33		12.98		14.9		17.48	
18	2.5		4.66		8.22		11		16.67		20.13		22.45			
24	3.64	2.16	6.55	3.95	11.18	6.73	14.62	8.79	21.09	12.69	24.74	14.88				
30	4.68	2.79	8.45	5.02	14	8.31	17.92	10.65	24.88	14.79	28.58	17				
45	7.59	4.32	12.2	7.43	19.03	11.59	23.41	14.27	30.38	18.52						
60		5.62		9.31		13.86		16.56		20.55						
80	11.96	7.25	19	11.54	26.92	16.35	31.28	18.99								
100		8.51		13.07		17.84										
120	16.23	9.74	24.16	14.49	31.95	19.18										
160		11.77		16.68		21.09										

Nota: 1. Las capacidades de potencia que se encuentran a la derecha de la línea gruesa no son recomendadas debido a que la velocidad lineal excede los 1000 pies por minuto. Sólo deben ser usados para interpolación.

2. Los engranes no metálicos se usan a menudo como piñón motriz de engranes de acero o de hierro fundido en aplicaciones en las que la velocidad en la línea de paso excede los 1000 pies por minuto y en las que no exista carga por impacto.

Capacidad de Potencia HP de Engranés Rectos

Ángulo de Presión de 14½°



(S) = Acero

(CI) = Hierro Fundido

6 DP Cara de 1½"

Número de Dientes	100 RPM		200 RPM		300 RPM		600 RPM		900 RPM		1200 RPM		1800 RPM	
	S	CI	S	CI	S	CI	S	CI	S	CI	S	CI	S	CI
12	1.54		2.83		3.97		6.57		8.4		9.78		11.69	
18	2.83		5.09		6.91		10.8		13.28		14.98		17.22	
24	4.02		7.02		9.32		13.86		16.56		18.35			
30	5.16		8.75		11.41		16.35		19.1					
36	6.26	3.77	10.37	6.24	13.28	7.98	18.44	11.09						
48	7.56	4.88	12.91	7.75	15.98	9.64	20.66	12.75						
84	12.86	7.6	17.62	11.02	20.51	12.96								
120	15.99	9.5	20.86	12.95										
180		12		15										

8 DP Cara de 1¼"

Número de Dientes	100 RPM		200 RPM		300 RPM		600 RPM		900 RPM		1200 RPM		1800 RPM	
	S	CI	S	CI	S	CI	S	CI	S	CI	S	CI	S	CI
12	0.72		1.37		1.95		3.32		4.36		5.21		6.38	
18	1.37		2.52		3.49		5.69		7.2		8.30		9.8	
24	1.98	1.18	3.59	2.13	4.81	2.86	7.55	4.48	9.25	5.49	10.48	6.22	12.08	7.17
36	3.02		5.13		6.73		9.85							
48	4.08	2.5	6.76	4.14	8.58	5.26	11.91	7.29						
60		2.98		4.79		5.98								
72		3.47		5.45		6.67								
96		4.4		6.49		7.75								
112		4.83		7.01										
120		5.05		7.22										
160		6.02		8.21										

10 DP Cara de 1"

Número de Dientes	100 RPM		200 RPM		300 RPM		600 RPM		900 RPM		1200 RPM		1800 RPM	
	S	CI	S	CI	S	CI	S	CI	S	CI	S	CI	S	CI
12	0.38		0.75		1.08		1.88		2.50		3.00		3.75	
18	0.72		1.33		1.87		3.15		4.07		4.76		5.75	
24	1.08		1.98		2.71		4.33		5.41		7.21		7.21	
28	1.24	0.80	2.24	1.44	3.06	1.94	4.83	3.03	5.98	3.71	6.79	4.85	7.85	
48	2.26	1.31	3.77	2.23	4.94	2.91	7.13	4.2	8.23	4.92				
60	2.68	1.61	4.45	2.66	5.65	3.41	7.84	4.73	9.04	5.43				
72		1.88		3.02		3.80		5.16						
96		2.37		3.65		4.46		5.73						
120		2.80		4.17		4.98		6.18						
140		3.12		4.52		5.33								
180		3.63		5.04		5.81								
200		3.88		5.29		6.02								

Nota: 1. Las capacidades de potencia que se encuentran a la derecha de la línea gruesa no son recomendadas debido a que la velocidad lineal excede los 1000 pies por minuto. Sólo deben ser usados para interpolación..

2. Los engranes no metálicos se usan a menudo como piñón motriz de engranes de acero o de hierro fundido en aplicaciones en las que la velocidad en la línea de paso excede los 1000 pies por minuto y en las que no exista carga por impacto.

12 DP Cara de 3/4"

Número de Dientes	100 RPM		200 RPM		300 RPM		600 RPM		900 RPM		1200 RPM		1800 RPM	
	S	CI	S	CI	S	CI	S	CI	S	CI	S	CI	S	CI
12	0.21		0.39		0.55		0.99		1.33		1.64		2.09	
18	0.38		0.71		1.01		1.73		2.28		2.70		3.32	
24	0.56		1.05		1.43		2.37		3.01		3.50		4.17	
36	0.88	0.53	1.57	0.95	2.13	1.28	3.33	2.01	4.09	2.46	4.62	2.46	5.31	3.21
48	1.16	0.70	2.02	1.22	2.70	1.62	3.99	2.41	4.76	2.88	4.76	3.19		
60	1.46	0.87	2.44	1.47	3.19	1.91	4.61	2.74	5.32	3.21				
72	1.71	1.04	2.84	1.72	3.60	2.18	5.00	3.03	5.76	3.49				
96		1.30		2.06		2.56		3.39						
120		1.54		2.37		2.90		3.68						
200		2.19		3.08		3.56								

16 DP Cara de 1/2"

Número de Dientes	100 RPM		200 RPM		300 RPM		600 RPM		900 RPM		1200 RPM		1800 RPM	
	S	CI	S	CI	S	CI	S	CI	S	CI	S	CI	S	CI
12	0.08		0.14		0.21		0.40		0.53		0.66		0.87	
18	0.14		0.27		0.39		0.70		0.94		1.14		1.44	
24	0.21		0.39		0.56		0.96		1.26		1.50		1.84	
36	0.32	0.14	0.60	0.27	0.82	0.37	1.35	0.60	1.71	0.68	1.97	0.87	2.33	1.03
48	0.45		0.82		1.10		1.72		2.11		2.39		2.75	
60		0.34		0.60		0.80		1.20		1.44		1.60		
72		0.40		0.69		0.91		1.33		1.57				
80	0.76	0.45	1.26	0.75	1.65	0.99	2.38	1.43	2.75	1.64				
120		0.63		1.00		1.25		1.68						
160		0.78		1.21		1.48		1.78						
200		0.93		1.34		1.60		1.78						

20 DP Cara de 3/8"

Número de Dientes	100 RPM		200 RPM		300 RPM		600 RPM		900 RPM		1200 RPM		1800 RPM	
	S	CI	S	CI	S	CI	S	CI	S	CI	S	CI	S	CI
12	0.05		0.07		0.10		0.19		0.27		0.33		0.46	
18	0.07		0.13		0.19		0.35		0.48		0.59		0.76	
24	0.11		0.20		0.29		0.51		0.68		0.81		1.02	
48	0.22	0.14	0.43	0.26	0.58	0.35	0.93	0.56	1.16	0.70	1.34	0.81	1.55	0.94
60	0.28		0.50		0.67		1.06		1.29		1.47		1.69	
80		0.22		0.39		0.52		0.76		0.91		1.01		
96	0.46	0.26	0.76	0.39	0.99	0.52	1.44	0.76	1.66	0.91	1.70	1.01		
120		0.32		0.53		0.66		0.92		1.06				
160		0.40		0.64		0.79		1.05		1.16				
200		0.47		0.73		0.89		1.08		1.14				

24 DP Cara de 1/4"

Número de Diente	100 RPM		200 RPM		300 RPM		600 RPM		900 RPM		1200 RPM	
	S	CI	S	CI	S	CI	S	CI	S	CI	S	CI
12	0.017		0.033		0.049		0.092		0.131		0.165	
18	0.030		0.060		0.090		0.170		0.230		0.290	
24	0.047		0.091		0.132		0.236		0.321		0.391	
36	0.080		0.150		0.210		0.360		0.470		0.550	
48	0.105		0.197		0.275		0.455		0.583		0.679	
60	0.130		0.240		0.330		0.530		0.670		0.760	
96	0.210		0.360		0.480		0.710		0.850		0.940	
144	0.291		0.482		0.617		0.857		0.984			

Nota: 1. Las capacidades de potencia que se encuentran a la derecha de la línea gruesa no son recomendadas debido a que la velocidad lineal excede los 1000 pies por minuto. Sólo deben ser usados para interpolación.

2. Los engranes no metálicos se usan a menudo como piñón motriz de engranes de acero o de hierro fundido en aplicaciones en las que la velocidad en la línea de paso excede los 1000 pies por minuto y en las que no exista carga por impacto.

4 DP Cara 3 1/2"

Engranos Rectos de Acero en Existencia

Ángulo de Presión 20°



Tipo B
Sencillo con Maza
en Acero

Tipo B₁
Con Alma
en Acero

Tipo B₂
Con Alma y Barrenos de
Aligeramiento
en Acero

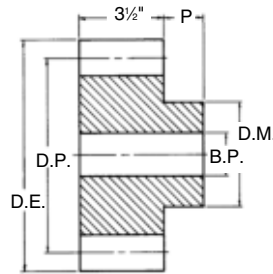

Tipo B

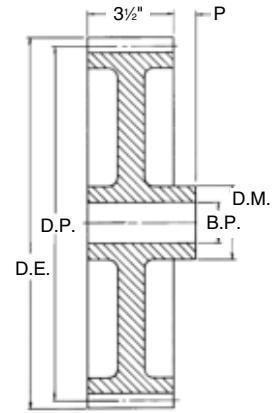

Tipo B₁, B₂

Acero

Número de Dientes	Número de Parte	Ángulo de Presión	Diámetro		Tipo	Barreno (Pulg.)		Maza (Pulg.)		Peso Aprox. (lb)
			Paso	Exterior		Piloto	Máx.*	Diámetro	Proy.	
12	TS412	20	3.000	3.500	B	1 1/8	1 1/8	2 1/4	7/8	6.8
14	TS414	20	3.500	4.000	B	1 1/8	1 1/8	2 3/4	7/8	9.8
15	TS415	20	3.750	4.250	B	1 1/8	1 1/8	3 1/4	7/8	11.5
16	TS416	20	4.000	4.500	B	1 1/8	2 1/8	3 3/4	7/8	13.3
18	TS418	20	4.500	5.000	B	1 1/8	2 3/8	3 7/8	7/8	17.3
20	TS420	20	5.000	5.500	B	1 1/8	2 3/4	4 1/4	7/8	21.8
22	TS422	20	5.500	6.000	B	1 1/8	3	4 3/4	7/8	26.7
24	TS424	20	6.000	6.500	B	1 1/8	3 1/8	5	1 1/4	33.7
28	TS428	20	7.000	7.500	B	1 1/8	3 3/8	5	1 1/4	43.8
30	TS430	20	7.500	8.000	B	1 1/8	3 3/8	5	1 1/4	49.4
32	TS432	20	8.000	8.500	B	1 1/8	3 3/8	5	1 1/2	56.8
36	TS436	20	9.000	9.500	B	1 1/4	3 3/8	5	1 1/2	70.0
40	TS440	20	10.000	10.500	B	1 1/4	3 3/8	5 1/2	1 1/2	85.2
44	TS444	20	11.000	11.500	B	1 1/4	3 3/8	5 3/8	1 1/2	101.6
48	TS448	20	12.000	12.500	B	1 1/4	3 3/8	5 3/8	1 1/2	119.5
56	TS456	20	14.000	14.500	B ₁	1 1/4	3 3/8	5 1/2	1 1/2	96.9
60	TS460	20	15.000	15.500	B ₂	1 1/4	3 3/8	5 1/2	1 1/2	88.1
64	TS464	20	16.000	16.500	B ₂	1 1/4	3 3/8	5 1/2	1 1/2	86.9
72	TS472	20	18.000	18.500	B ₂	1 1/4	3 3/8	5 1/2	1 1/2	86.5
80	TS480	20	20.000	20.500	B ₂	1 1/4	3 3/8	5 1/2	1 1/2	90.9

* Barreno máximo recomendado con cuñero y opressor.

Los engranes con ángulo de presión de 20° no operan con engranes con ángulo de presión de 14 1/2°.

Martin

Engranos Rectos de Acero en Existencia

Ángulo de Presión 20°

5 DP Cara 2 1/2"

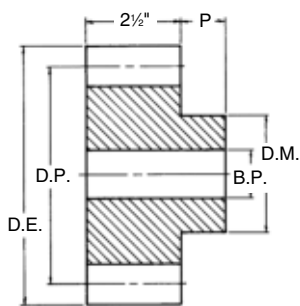

Tipo B

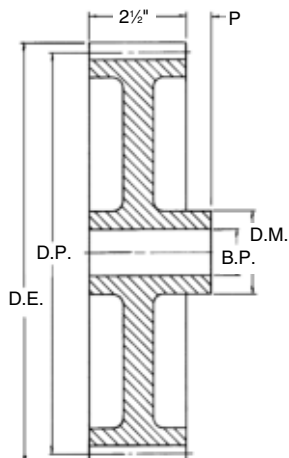

Tipo B₂



Tipo B
Sencillo con
Maza en Acero



Tipo B₂
Con Alma y Barrenos
de Aligeramiento en Acero

Acero

Número de Dientes	Número de Parte	Ángulo de Presión	Diámetro		Tipo	Barreno (Pulg.)		Maza (Pulg.)		Peso Aprox. (lb)
			Paso	Exterior		Piloto	Máx.*	Diámetro	Proy.	
12	TS512	20	2.400	2.800	B	1 1/8	1 1/8	1 7/8	7/8	2.9
14	TS514	20	2.800	3.200	B	1 1/8	1 1/8	2 3/8	7/8	4.3
15	TS515	20	3.000	3.400	B	1 1/8	1 1/8	2 1/8	7/8	5.2
16	TS516	20	3.200	3.600	B	1 1/8	1 1/8	2 13/16	7/8	6.1
18	TS518	20	3.600	4.000	B	1 1/8	1 1/8	3	7/8	8.0
20	TS520	20	4.000	4.400	B	1 1/8	2 1/8	3 3/8	7/8	10.2
24	TS524	20	4.800	5.200	B	1 1/8	2 3/8	3 3/4	1 1/4	15.7
25	TS525	20	5.000	5.400	B	1 1/8	2 3/8	3 3/8	1 1/4	20.3
28	TS528	20	5.600	6.000	B	1 1/8	2 3/8	3 3/4	1 1/4	22.9
30	TS530	20	6.000	6.400	B	1 1/8	2 3/8	3 3/8	1 1/4	23.9
35	TS535	20	7.000	7.400	B	1 1/8	2 3/8	3 3/4	1 1/4	29.9
40	TS540	20	8.000	8.400	B	1 1/8	2 3/8	3 3/4	1 1/4	38.2
45	TS545	20	9.000	9.400	B	1 1/8	2 3/8	3 3/8	1 1/4	47.7
50	TS550	20	10.000	10.400	B	1 1/8	2 13/16	4 1/8	1 1/4	60.3
60	TS560	20	12.000	12.400	B	1 1/8	2 13/16	4 3/8	1 1/4	84.7
70	TS570	20	14.000	14.400	B ₂	1 3/16	3 1/8	5 1/8	1 1/4	51.6
80	TS580	20	16.000	16.400	B ₂	1 3/16	3 1/8	5 1/4	1 1/4	55.8
90	TS590	20	18.000	18.400	B ₂	1 3/16	3 1/8	5 1/4	1 1/4	59.7
100	TS5100	20	20.000	20.400	B ₂	1 3/16	3 1/8	5 1/4	1 1/2	69.2
110	TS5110	20	22.000	22.400	B ₂	1 3/16	3 1/8	5 3/4	1 1/2	72.3
120	TS5120	20	24.000	24.400	B ₂	1 3/16	3 1/8	6 1/4	1 1/2	80.2

* Barreno máximo recomendado con cuñero y opresor.

Los engranes con ángulo de presión de 20° no operan con engranes con ángulo de presión de 14 1/2°.

6 DP Cara 2"

Engranos Rectos de Acero en Existencia

Ángulo de Presión 20°



Tipo B
Sencillo con Maza
en Acero



Tipo B₂
Con Alma y Barrenos de
Aligeramiento en Acero

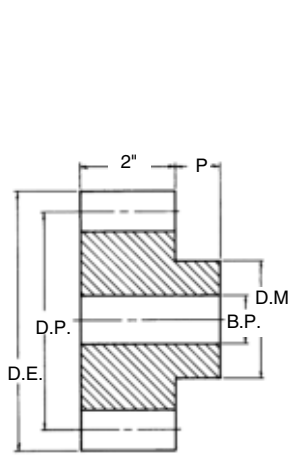

Tipo B

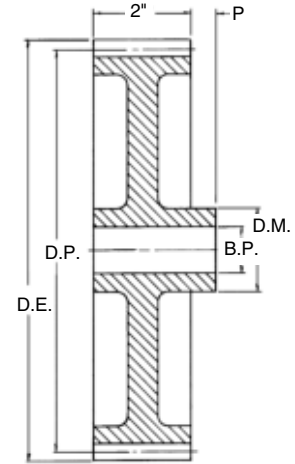

Tipo B₂

Acero

Número de Dientes	Número de Parte	Ángulo de Presión	Diámetro		Tipo	Barreno (Pulg.)		Maza (Pulg.)		Peso Aprox. (lb)
			Paso	Exterior		Piloto	Máx.*	Diámetro	Proy.	
11	TS611†	20	2.000	2.333	B	1	1	1½	¾	1.6
12	TS612	20	2.000	2.333	B	1	1	1½	¾	1.6
14	TS614	20	2.333	2.666	B	1	1	1⅝	¾	2.4
15	TS615	20	2.500	2.833	B	1	1¼	2	¾	2.9
16	TS616	20	2.666	3.000	B	1	1⅞	2½	¾	3.4
18	TS618	20	3.000	3.333	B	1	1½	2½	¾	4.6
21	TS621	20	3.500	3.833	B	1	1½	3	¾	6.6
24	TS624	20	4.000	4.333	B	1½	1½	3	¾	8.1
27	TS627	20	4.500	4.833	B	1½	2½	3½	¾	10.6
30	TS630	20	5.000	5.333	B	1½	2½	4	¾	13.4
33	TS633	20	5.500	5.833	B	1½	2½	4	1½	17.8
36	TS636	20	6.000	6.333	B	1½	2½	4	1½	20.4
42	TS642	20	7.000	7.333	B	1½	2½	4	1½	26.2
48	TS648	20	8.000	8.333	B	1½	2½	4	1½	32.8
54	TS654	20	9.000	9.333	B	1½	2½	4	1½	40.4
60	TS660	20	10.000	10.333	B	1½	2⅞	4½	1½	50.0
64	TS664	20	10.666	11.000	B	1½	2⅞	4½	1½	56.5
66	TS666	20	11.000	11.333	B	1½	2⅞	4½	1½	59.8
72	TS672	20	12.000	12.333	B	1½	2⅞	4½	1½	70.0
84	TS684	20	14.000	14.333	B ₂	1½	2⅞	5	1½	42.8
96	TS696	20	16.000	16.333	B ₂	1½	2⅞	5	1½	46.0
108	TS6108	20	18.000	18.333	B ₂	1½	2⅞	5	1½	48.8
120	TS6120	20	20.000	20.333	B ₂	1½	2⅞	5	1½	51.3

* Barreno máximo recomendado con cuñero y opositor.

† Diámetro de paso alargado con forma especial del diente.

Barreno a la Medida

Número de Dientes	Número de Parte	Ángulo de Presión	Diámetro		Tipo	Barreno (Pulg.)		Opositor	Maza (Pulg.)		Peso Aprox. (lb)
			Paso	Exterior		Piloto	Cuñero		Diámetro	Proy.	
12	TS612BS 1	20	2.000	2.333	B	1	¼ x ¼	(1) 1/4-20 @90°	1½	¾	1.60
14	TS614BS 1	20	2.333	2.667	B	1	¼ x ¼	(1) 5/16-18 @90°	1⅞	¾	2.40
14	TS614BS 1-1/8	20	2.333	2.667	B	1½	¼ x ¼	(1) 5/16-18 @90°	1⅞	¾	2.40
15	TS615BS 1	20	2.500	2.833	B	1	¼ x ¼	(1) 5/16-18 @90°	2	¾	2.90
15	TS615BS 1-1/8	20	2.500	2.833	B	1½	¼ x ¼	(1) 5/16-18 @90°	2	¾	2.90
15	TS615BS 1-3/16	20	2.500	2.833	B	1½	¼ x ¼	(1) 5/16-18 @90°	2	¾	2.90
15	TS615BS 1-1/4	20	2.500	2.833	B	1½	¼ x ¼	(1) 5/16-18 @90°	2	¾	2.90
16	TS616BS 1	20	2.667	3.000	B	1	¼ x ¼	(1) 5/16-18 @90°	2½	¾	3.40
16	TS616BS 1-1/8	20	2.667	3.000	B	1½	¼ x ¼	(1) 5/16-18 @90°	2½	¾	3.40
16	TS616BS 1-3/16	20	2.667	3.000	B	1½	¼ x ¼	(1) 5/16-18 @90°	2½	¾	3.40
16	TS616BS 1-1/4	20	2.667	3.000	B	1½	¼ x ¼	(1) 5/16-18 @90°	2½	¾	3.40
18	TS618BS 1	20	3.000	3.333	B	1	¼ x ¼	(1) 5/16-18 @90°	2½	¾	4.60
18	TS618BS 1-1/8	20	3.000	3.333	B	1½	¼ x ¼	(1) 5/16-18 @90°	2½	¾	4.60
18	TS618BS 1-3/16	20	3.000	3.333	B	1½	¼ x ¼	(1) 5/16-18 @90°	2½	¾	4.60
18	TS618BS 1-1/4	20	3.000	3.333	B	1½	¼ x ¼	(1) 5/16-18 @90°	2½	¾	4.60
21	TS621BS 1	20	3.500	3.833	B	1	¼ x ¼	(1) 5/16-18 @90°	3	¾	6.60
21	TS621BS 1-1/8	20	3.500	3.833	B	1½	¼ x ¼	(1) 5/16-18 @90°	3	¾	6.60
21	TS621BS 1-3/16	20	3.500	3.833	B	1½	¼ x ¼	(1) 5/16-18 @90°	3	¾	6.60
21	TS621BS 1-1/4	20	3.500	3.833	B	1½	¼ x ¼	(1) 5/16-18 @90°	3	¾	6.60

Los engranes con ángulo de presión de 20° no operan con engranes con ángulo de presión de 14½°.

Martin

Engranos Rectos de Acero y Hierro Fundido en Existencia

Angulo de Presión 20°

8 DP

Cara 1½"

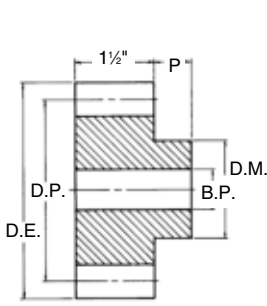

Acero
Tipo B

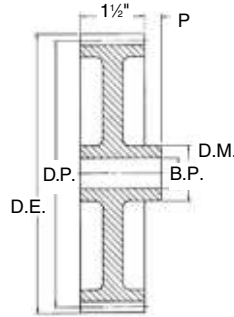

Tipo B₂, B₃



Tipo B
Sencillo con Maza en Acero



Tipo B₃
Con Alma y Rayos de Hierro Fundido

Número de Dientes	Número de Parte	Angulo de Presión	Diámetro		Tipo	Barreno (Pulg.)		Maza (Pulg.)		Peso Aprox. (lb)
			Paso	Exterior		Piloto	Máx.*	Diámetro	Proy.	
12	TS812	20	1.500	1.750	B	3/4	3/4	1 1/8	3/4	0.7
14	TS814	20	1.750	2.000	B	3/4	13/16	1 1/8	3/4	1.0
15	TS815	20	1.875	2.125	B	3/4	7/8	1 1/8	3/4	1.2
16	TS816	20	2.000	2.250	B	3/4	15/16	1 1/8	3/4	1.4
18	TS818	20	2.250	2.500	B	7/8	1 1/8	1 13/16	7/8	1.9
19	TS819	20	2.375	2.625	B	7/8	1 1/4	2	7/8	2.3
20	TS820	20	2.500	2.750	B	7/8	1 1/2	2 1/8	7/8	2.5
22	TS822	20	2.750	3.000	B	7/8	1 1/2	2 3/8	7/8	3.2
24	TS824	20	3.000	3.250	B	7/8	1 3/4	2 3/4	7/8	3.9
26	TS826	20	3.250	3.500	B	7/8	1 3/4	2 3/4	7/8	4.6
28	TS828	20	3.500	3.750	B	7/8	1 3/4	2 3/4	7/8	5.2
30	TS830	20	3.750	4.000	B	1	1 3/4	2 3/4	7/8	5.6
32	TS832	20	4.000	4.250	B	1	1 3/4	3 1/8	7/8	6.6
36	TS836	20	4.500	4.750	B	1	2 1/8	3 1/2	7/8	8.6
40	TS840	20	5.000	5.250	B	1	2 1/8	3 1/2	7/8	10.2
42	TS842	20	5.250	5.500	B	1	2 1/8	3 1/2	1	11.4
44	TS844	20	5.500	5.750	B	1	2 1/8	3 1/2	1	12.3
48	TS848	20	6.000	6.250	B	1	2 1/8	3 1/2	1	14.2

Hierro Fundido

Número de Dientes	Número de Parte	Angulo de Presión	Diámetro		Tipo	Barreno (Pulg.)		Maza (Pulg.)		Peso Aprox. (lb)
			Paso	Exterior		Piloto	Máx.*	Diámetro	Proy.	
52	TC852	20	6.500	6.750	B	1	1 1/8	3	1	11.9
56	TC856	20	7.000	7.250	B	1	1 1/8	3	1	13.0
60	TC860	20	7.500	7.750	B ₂	1	1 1/8	3	1	12.0
64	TC864	20	8.000	8.250	B ₃	1	1 1/8	3	1	12.1
72	TC872	20	9.000	9.250	B ₃	1	2 1/8	3 3/4	1 1/4	14.4
80	TC880	20	10.000	10.250	B ₃	1 1/8	2 1/8	3 3/4	1 1/4	17.0
88	TC888	20	11.000	11.250	B ₃	1 1/8	2 1/8	3 3/4	1 1/4	19.0
96	TC896	20	12.000	12.250	B ₃	1 1/8	2 1/8	3 3/4	1 1/4	23.7
112	TC8112	20	14.000	14.250	B ₃	1 1/8	2 1/8	3 3/4	1 1/4	25.0
120	TC8120	20	15.000	15.250	B ₃	1 1/8	2 1/8	3 3/4	1 1/4	25.8
128	TC8128	20	16.000	16.250	B ₃	1 1/8	2 1/8	3 3/4	1 1/4	28.0
144	TC8144	20	18.000	18.250	B ₃	1 1/8	2 1/8	3 3/4	1 1/4	32.0
160	TC8160	20	20.000	20.250	B ₃	1 1/8	2 1/8	3 3/4	1 1/4	34.8

Barreno a la Medida

* Barreno máximo recomendado con cuñero y opresor

Número de Dientes	Número de Parte	Ángulo de Presión	Diámetro		Tipo	Barreno (Pulg.)		Opresor	Maza (Pulg.)		Peso Aprox. (lb)
			Paso	Exterior		Piloto	Cuñero		Diámetro	Proy.	
12	TS812BS 3/4	20	1.500	1.750	B	3/4	3/8 x 3/32	(1) 10-24 @90°	1 1/8	3/4	0.70
14	TS814BS 3/4	20	1.750	2.000	B	3/4	3/8 x 3/32	(1) 1/4-20 @90°	1 1/8	3/4	1.00
15	TS815BS 3/4	20	1.875	2.125	B	3/4	3/8 x 3/32	(1) 1/4-20 @90°	1 1/8	3/4	1.20
15	TS815BS 7/8	20	1.875	2.125	B	7/8	3/8 x 3/32	(1) 1/4-20 @90°	1 1/8	3/4	1.20
16	TS816BS 7/8	20	2.000	2.250	B	7/8	3/8 x 3/32	(1) 1/4-20 @90°	1 1/8	7/8	1.40
16	TS816BS 1	20	2.000	2.250	B	1	1/4 x 1/8	(1) 5/16-18 @90°	1 1/8	7/8	1.40
18	TS818BS 7/8	20	2.250	2.500	B	7/8	3/8 x 3/32	(1) 1/4-20 @90°	1 13/16	7/8	1.90
18	TS818BS 1	20	2.250	2.500	B	1	1/4 x 1/8	(1) 5/16-18 @90°	1 13/16	7/8	1.90
18	TS818BS 1-1/8	20	2.250	2.500	B	1 1/8	1/4 x 1/8	(1) 5/16-18 @90°	1 13/16	7/8	1.90
20	TS820BS 7/8	20	2.500	2.750	B	7/8	3/8 x 3/32	(1) 1/4-20 @90°	2 1/16	7/8	2.50
20	TS820BS 1	20	2.500	2.750	B	1	1/4 x 1/8	(1) 5/16-18 @90°	2 1/16	7/8	2.50
20	TS820BS 1-1/8	20	2.500	2.750	B	1 1/8	1/4 x 1/8	(1) 5/16-18 @90°	2 1/16	7/8	2.50
22	TS822BS 7/8	20	2.750	3.000	B	7/8	3/8 x 3/32	(1) 1/4-20 @90°	2 3/16	7/8	3.20
22	TS822BS 1	20	2.750	3.000	B	1	1/4 x 1/8	(1) 5/16-18 @90°	2 3/16	7/8	3.20
22	TS822BS 1-1/8	20	2.750	3.000	B	1 1/8	1/4 x 1/8	(1) 5/16-18 @90°	2 3/16	7/8	3.20
24	TS824BS 7/8	20	3.000	3.250	B	7/8	3/8 x 3/32	(1) 1/4-20 @90°	2 3/16	7/8	3.90
24	TS824BS 1	20	3.000	3.250	B	1	1/4 x 1/8	(1) 5/16-18 @90°	2 3/16	7/8	3.90
24	TS824BS 1-1/8	20	3.000	3.250	B	1 1/8	1/4 x 1/8	(1) 5/16-18 @90°	2 3/16	7/8	3.90

Los engranes con ángulo de presión de 20° no operan con engranes con ángulo de presión de 14½°.

10 DP Cara 1 1/4"

Engranos Rectos de Acero y Hierro Fundido en Existencia

Angulo de Presión 20°

Martin



Tipo B
Sencillo con Maza
en Acero



Tipo B₃
Con Alma y Rayos
de Hierro Fundido

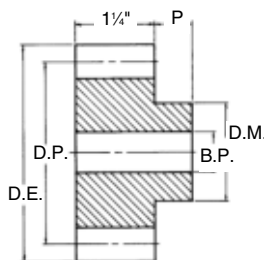

Tipo B

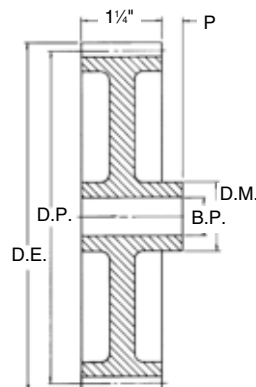

Tipo B₃

Acero

Número de Dientes	Número de Parte	Angulo de Presión	Diámetro		Tipo	Barreno (Pulg.)		Maza (Pulg.)		Peso Aprox. (lb)
			Paso	Exterior		Piloto	Máx.*	Diámetro	Proy.	
12	TS1012	20	1.200	1.400	B	3/8	3/8	29/32	3/8	0.4
14	TS1014	20	1.400	1.600	B	3/8	3/8	1 1/4	3/8	0.6
15	TS1015	20	1.500	1.700	B	3/8	3/8	1 1/2	3/8	0.6
16	TS1016	20	1.600	1.800	B	3/8	3/8	1 5/8	3/8	0.7
18	TS1018	20	1.800	2.000	B	7/8	1 1/8	1 1/2	3/8	0.9
20	TS1020	20	2.000	2.200	B	7/8	7/8	1 3/4	3/8	1.2
22	TS1022	20	2.200	2.400	B	7/8	1 1/8	1 7/8	3/8	1.5
24	TS1024	20	2.400	2.600	B	7/8	1 1/8	2 1/4	3/8	1.8
25	TS1025	20	2.500	2.700	B	7/8	1 1/4	2 3/4	3/8	2.0
26	TS1026	20	2.600	2.800	B	7/8	1 1/4	2 3/4	3/8	2.2
28	TS1028	20	2.800	3.000	B	7/8	1 1/2	2 3/2	3/8	2.7
30	TS1030	20	3.000	3.200	B	7/8	1 3/4	2 1/2	7/8	3.4
32	TS1032	20	3.200	3.400	B	7/8	1 3/4	2 1/2	7/8	3.7
35	TS1035	20	3.500	3.700	B	1	1 3/4	2 1/2	7/8	4.2
36	TS1036	20	3.600	3.800	B	1	1 3/4	2 1/2	7/8	4.3
40	TS1040	20	4.000	4.200	B	1	2 1/8	3 1/2	7/8	6.4
45	TS1045	20	4.500	4.700	B	1	2 3/8	3 1/2	7/8	7.5
48	TS1048	20	4.800	5.000	B	1	2 3/8	3 3/4	7/8	8.7
50	TS1050	20	5.000	5.200	B	1	2 3/8	4	7/8	9.6
55	TS1055	20	5.500	5.700	B	1	2 3/8	4	1	11.5
60	TS1060	20	6.000	6.200	B	1	2 3/8	4	1	13.1

Hierro Fundido

Número de Dientes	Número de Parte	Angulo de Presión	Diámetro		Tipo	Barreno (Pulg.)		Maza (Pulg.)		Peso Aprox. (lb)
			Paso	Exterior		Piloto	Máx.*	Diámetro	Proy.	
70	TC1070	20	7.000	7.200	B ₃	1	1 1/8	2 3/4	1	8.2
80	TC1080	20	8.000	8.200	B ₃	1	1 1/8	2 3/4	1	11.2
90	TC1090	20	9.000	9.200	B ₃	1	1 1/8	3	1	11.7
100	TC10100	20	10.000	10.200	B ₃	1 1/8	1 1/8	3	1 1/8	12.2

* Barreno máximo recomendado con cuñero y opresor.

Barreno a la Medida

Número de Dientes	Número de Parte	Angulo de Presión	Diámetro		Tipo	Barreno (Pulg.)		Opresor	Maza (Pulg.)		Peso Aprox. (lb)
			Paso	Exterior		Piloto	Cuñero		Diámetro	Proy.	
12	TS1012BS 5/8	20	1.200	1.400	B	3/8	3/8 x 3/8	(1) 10-24 @90°	29/32	3/8	0.40
14	TS1014BS 5/8	20	1.400	1.600	B	3/8	3/8 x 3/8	(1) 1/4-20 @90°	1 1/4	3/8	0.60
15	TS1015BS 3/4	20	1.500	1.700	B	3/8	3/8 x 3/8	(1) 1/4-20 @90°	1 1/2	3/8	0.60
16	TS1016BS 3/4	20	1.600	1.800	B	3/8	3/8 x 3/8	(1) 1/4-20 @90°	1 5/8	3/8	0.70
18	TS1018BS 7/8	20	1.800	2.000	B	7/8	3/8 x 3/8	(1) 1/4-20 @90°	1 1/2	3/8	0.90
20	TS1020BS 7/8	20	2.000	2.200	B	7/8	3/8 x 3/8	(1) 1/4-20 @90°	1 3/4	3/8	1.20
20	TS1020BS 1	20	2.000	2.200	B	1	1/2 x 1/2	(1) 5/16-18 @90°	1 3/4	3/8	1.20
24	TS1024BS 7/8	20	2.400	2.600	B	7/8	3/8 x 3/8	(1) 1/4-20 @90°	1 13/16	3/8	1.50
24	TS1024BS 1	20	2.400	2.600	B	1	1/2 x 1/2	(1) 5/16-18 @90°	1 13/16	3/8	1.50
25	TS1025BS 7/8	20	2.500	2.700	B	7/8	3/8 x 3/8	(1) 1/4-20 @90°	2 1/4	3/8	2.00
25	TS1025BS 1	20	2.500	2.700	B	1	1/2 x 1/2	(1) 5/16-18 @90°	2 3/4	3/8	2.00
28	TS1028BS 7/8	20	2.800	3.000	B	7/8	3/8 x 3/8	(1) 1/4-20 @90°	2 1/2	3/8	2.70
28	TS1028BS 1	20	2.800	3.000	B	1	1/2 x 1/2	(1) 5/16-18 @90°	2 1/2	3/8	2.70

Los engranes con ángulo de presión de 20° no operan con engranes con ángulo de presión de 14 1/2°.

Martin

Engranos Rectos de Acero y Hierro Fundido en Existencia

Ángulo de Presión 20°

12 DP

Cara 1"

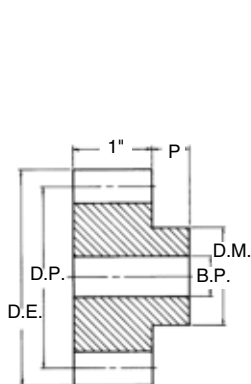

Tipo B

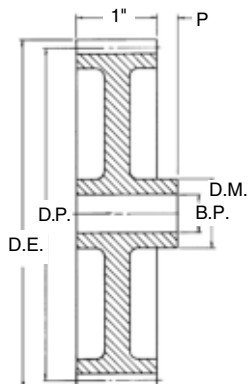

Tipo B₃



Tipo B
Sencillo con Maza
en Acero



Tipo B₃
Con Alma y Rayos
de Hierro Fundido

Acero

Número de Dientes	Número de Parte	Ángulo de Presión	Diámetro		Tipo	Barreno (Pulg.)		Maza (Pulg.)		Peso Aprox. (lb)
			Paso	Exterior		Piloto	Máx.*	Diámetro	Proy.	
12	TS1212	20	1.000	1.167	B	1/2	1/2	3/4	5/8	0.21
13	TS1213	20	1.083	1.250	B	5/8	5/8	13/16	5/8	0.21
14	TS1214	20	1.167	1.333	B	5/8	5/8	29/32	5/8	0.28
15	TS1215	20	1.250	1.417	B	5/8	5/8	63/64	5/8	0.34
16	TS1216	20	1.333	1.500	B	5/8	5/8	1 1/16	5/8	0.41
18	TS1218	20	1.500	1.667	B	3/4	3/4	1 1/4	5/8	0.51
19	TS1219	20	1.583	1.750	B	3/4	3/4	1 3/16	5/8	0.59
20	TS1220	20	1.667	1.833	B	3/4	3/4	1 1/16	5/8	0.65
21	TS1221	20	1.750	1.917	B	3/4	7/16	1 5/16	5/8	0.75
22	TS1222	20	1.833	2.000	B	3/4	7/16	1 1/16	5/8	0.88
24	TS1224	20	2.000	2.166	B	3/4	7/16	1 1/4	5/8	1.06
25	TS1225	20	2.083	2.250	B	3/4	1 1/16	1 1/16	5/8	1.22
26	TS1226	20	2.167	2.333	B	3/4	1 1/8	1 1/8	5/8	1.33
28	TS1228	20	2.333	2.500	B	3/4	1 1/4	2 1/16	5/8	1.60
30	TS1230	20	2.500	2.667	B	3/4	1 3/8	2 5/16	5/8	1.83
32	TS1232	20	2.667	2.833	B	3/4	1 3/8	2 1/4	5/8	2.08
36	TS1236	20	3.000	3.167	B	3/4	1 3/8	2 1/2	7/8	2.98
42	TS1242	20	3.500	3.666	B	3/4	1 3/8	2 1/2	7/8	3.71
48	TS1248	20	4.000	4.166	B	7/8	1 3/8	3	7/8	4.99
54	TS1254	20	4.500	4.666	B	7/8	2 1/8	3 1/2	7/8	6.57
60	TS1260	20	5.000	5.166	B	7/8	2 1/8	3 1/2	7/8	7.63
66	TS1266	20	5.500	5.666	B	7/8	2 1/8	3 1/2	7/8	8.80
72	TS1272	20	6.000	6.166	B	7/8	2 1/8	3 1/2	7/8	10.08

Hierro Fundido

Número de Dientes	Número de Parte	Ángulo de Presión	Diámetro		Tipo	Barreno (Pulg.)		Maza (Pulg.)		Peso Aprox. (lb)
			Paso	Exterior		Piloto	Máx.*	Diámetro	Proy.	
84	TC1284	20	7.000	7.166	B ₃	7/8	1 1/16	2 1/2	7/8	5.9
96	TC1296	20	8.000	8.166	B ₃	7/8	1 1/16	2 1/2	7/8	7.0
108	TC12108	20	9.000	9.166	B ₃	7/8	1 1/16	2 1/2	7/8	7.6
120	TC12120	20	10.000	10.166	B ₃	1	1 1/16	2 1/2	7/8	10.3
144	TC12144	20	12.000	12.166	B ₃	1	1 1/16	2 1/2	1	10.4

* Barreno máximo recomendado con cuñero y opresor.

Barreno a la Medida

Número de Dientes	Número de Parte	Ángulo de Presión	Diámetro		Tipo	Barreno (Pulg.)		Opresor	Maza (Pulg.)		Peso Aprox. (lb)
			Paso	Exterior		Piloto	Cuñero		Diámetro	Proy.	
12	TS1212BS 1/2	20	1.000	1.167	B	1/2	NINGÚN	(1) 10-24	3/4	5/8	0.21
13	TS1213BS 5/8	20	1.083	1.250	B	5/8	NINGÚN	(1) 1/4-20 @ 90°	13/16	5/8	0.21
14	TS1214BS 5/8	20	1.167	1.333	B	5/8	3/16 x 3/32	(1) 10-24 @ 90°	29/32	5/8	0.28
15	TS1215BS 5/8	20	1.250	1.417	B	5/8	3/16 x 3/32	(1) 10-24 @ 90°	63/64	5/8	0.34
16	TS1216BS 5/8	20	1.333	1.500	B	5/8	3/16 x 3/32	(1) 1/4-20 @ 90°	1 1/16	5/8	0.41
18	TS1218BS 3/4	20	1.500	1.667	B	3/4	3/16 x 3/32	(1) 1/4-20 @ 90°	1 1/4	5/8	0.51
20	TS1220BS 3/4	20	1.667	1.833	B	3/4	3/16 x 3/32	(1) 1/4-20 @ 90°	1 3/16	5/8	0.65
21	TS1221BS 3/4	20	1.750	1.917	B	3/4	3/16 x 3/32	(1) 1/4-20 @ 90°	1 5/16	5/8	0.75
21	TS1221BS 7/8	20	1.750	1.917	B	7/8	3/16 x 3/32	(1) 1/4-20 @ 90°	1 5/16	5/8	0.75
24	TS1224BS 3/4	20	2.000	2.167	B	3/4	3/16 x 3/32	(1) 1/4-20 @ 90°	1 41/64	5/8	1.06
24	TS1224BS 7/8	20	2.000	2.167	B	7/8	3/16 x 3/32	(1) 1/4-20 @ 90°	1 41/64	5/8	1.06
24	TS1224BS 1	20	2.000	2.167	B	1	1/4 x 1/8	(1) 5/16-18 @ 90°	1 41/64	5/8	1.06
28	TS1228BS 3/4	20	2.333	2.500	B	3/4	3/16 x 3/32	(1) 1/4-20 @ 90°	2 1/16	5/8	1.60
28	TS1228BS 7/8	20	2.333	2.500	B	7/8	3/16 x 3/32	(1) 1/4-20 @ 90°	2 1/16	5/8	1.60
28	TS1228BS 1	20	2.333	2.500	B	1	1/4 x 1/8	(1) 5/16-18 @ 90°	2 1/16	5/8	1.60

Los engranes con ángulo de presión de 20° no operan con engranes con ángulo de presión de 14 1/2°.

16 DP Cara 3/4"

Engranos Rectos de Acero y Hierro Fundido en Existencia Ángulo de Presión 20°

Martin



Tipo B
Sencillo con Maza
en Acero



Tipo B₃
Con Alma y Rayos
de Hierro Fundido

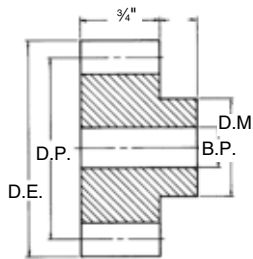

Tipo B

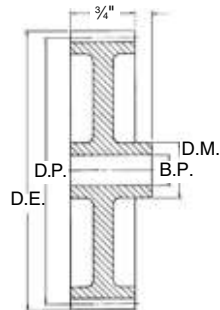

Tipo B₃

Acero

Número de Dientes	Número de Parte	Ángulo de Presión	Diámetro		Tipo	Barreno (Pulg.)		Maza (Pulg.)		Peso Aprox. (lb)
			Paso	Exterior		Piloto	Máx.*	Diámetro	Proy.	
12	TS1612	20	.750	.875	B	3/8	3/8	5/16	1/2	0.09
13	TS1613	20	.812	.938	B	3/8	3/8	5/16	1/2	0.11
14	TS1614	20	.875	1.000	B	3/8	3/8	11/16	1/2	0.14
15	TS1615	20	.937	1.063	B	3/8	1/2	3/4	1/2	0.17
16	TS1616	20	1.000	1.125	B	1/2	1/2	13/16	1/2	0.17
17	TS1617	20	1.062	1.188	B	1/2	1/2	7/8	1/2	0.20
18	TS1618	20	1.125	1.250	B	1/2	1/2	15/16	1/2	0.24
20	TS1620	20	1.250	1.375	B	5/8	5/8	1 1/16	1/2	0.28
21	TS1621	20	1.312	1.438	B	5/8	5/8	1 1/8	1/2	0.32
22	TS1622	20	1.375	1.500	B	5/8	5/8	1 1/16	1/2	0.36
24	TS1624	20	1.500	1.625	B	5/8	3/4	1 1/8	1/2	0.46
26	TS1626	20	1.625	1.750	B	5/8	7/8	1 1/16	1/2	0.56
28	TS1628	20	1.750	1.875	B	5/8	7/8	1 1/2	1/2	0.65
30	TS1630	20	1.875	2.000	B	5/8	15/16	1 1/8	1/2	0.77
32	TS1632	20	2.000	2.125	B	5/8	1	1 3/8	1/2	0.90
36	TS1636	20	2.250	2.375	B	5/8	1 1/4	2	1/2	1.18
40	TS1640	20	2.500	2.625	B	5/8	1 1/4	2	5/8	1.48
48	TS1648	20	3.000	3.125	B	5/8	1 1/4	2	5/8	1.94
56	TS1656	20	3.500	3.625	B	5/8	1 1/2	2 1/2	5/8	2.79
60	TS1660	20	3.750	3.875	B	5/8	1 1/2	2 3/4	5/8	3.28
64	TS1664	20	4.000	4.125	B	3/4	1 1/2	2 3/4	3/4	3.74
72	TS1672	20	4.500	4.625	B	3/4	1 1/2	3	3/4	4.69
80	TS1680	20	5.000	5.125	B	3/4	2	3 1/2	3/4	6.03
84	TS1684	20	5.250	5.375	B	3/4	2 1/2	3 1/2	3/4	6.46
96	TS1696	20	6.000	6.125	B	3/4	2 1/2	3 1/2	3/4	7.86
104	TS16104	20	6.500	6.625	B	3/4	2 1/2	3 1/2	3/4	8.91

Hierro Fundido

Número de Dientes	Número de Parte	Ángulo de Presión	Diámetro		Tipo	Barreno (Pulg.)		Maza (Pulg.)		Peso Aprox. (lb)
			Paso	Exterior		Piloto	Máx.*	Diámetro	Proy.	
112	TC16112	20	7.000	7.125	B ₃	3/4	1 1/16	2 1/2	3/4	4.4
128	TC16128	20	8.000	8.125	B ₃	3/4	1 1/16	2 3/4	3/4	5.5
144	TC16144	20	9.000	9.125	B ₃	3/4	1 1/16	2 3/4	3/4	6.4
160	TC16160	20	10.000	10.125	B ₃	3/4	1 1/16	2 3/4	3/4	8.1
192	TC16192	20	12.000	12.125	B ₃	3/4	1 1/16	3	1	10.1

Barreno a la Medida

* Barreno máximo recomendado con cuñero y opresor.

Número de Dientes	Número de Parte	Ángulo de Presión	Diámetro		Tipo	Barreno (Pulg.)		Opresor	Maza (Pulg.)		Peso Aprox. (lb)
			Paso	Exterior		Piloto	Cuñero		Diámetro	Proy.	
12	TS1612BS 3/8	20	0.750	0.875	B	3/8	NINGÚN	(1) 8-32	5/16	1/2	0.09
14	TS1614BS 3/8	20	0.875	1.000	B	3/8	NINGÚN	(1) 10-24	11/16	1/2	0.14
15	TS1615BS 3/8	20	0.937	1.063	B	3/8	NINGÚN	(1) 10-24	3/4	1/2	0.17
15	TS1615BS 1/2	20	0.937	1.063	B	1/2	NINGÚN	(1) 10-24	3/4	1/2	0.17
16	TS1616BS 1/2	20	1.000	1.125	B	1/2	NINGÚN	(1) 10-24	13/16	1/2	0.17
18	TS1618BS 1/2	20	1.125	1.250	B	1/2	NINGÚN	(1) 1/4-20	15/16	1/2	0.24
20	TS1620BS 5/8	20	1.250	1.375	B	5/8	3/16 x 3/32	(1) 1/4-20 @90°	1 1/16	1/2	0.28
24	TS1624BS 5/8	20	1.500	1.625	B	5/8	3/16 x 3/32	(1) 1/4-20 @90°	1 1/8	1/2	0.46
24	TS1624BS 3/4	20	1.500	1.625	B	3/4	3/16 x 3/32	(1) 1/4-20 @90°	1 1/8	1/2	0.46
28	TS1628BS 5/8	20	1.750	1.875	B	5/8	3/16 x 3/32	(1) 1/4-20 @90°	1 1/2	1/2	0.65
28	TS1628BS 3/4	20	1.750	1.875	B	3/4	3/16 x 3/32	(1) 1/4-20 @90°	1 1/2	1/2	0.65
30	TS1630BS 5/8	20	1.875	2.000	B	5/8	3/16 x 3/32	(1) 1/4-20 @90°	1 1/2	1/2	0.77
30	TS1630BS 3/4	20	1.875	2.000	B	3/4	3/16 x 3/32	(1) 1/4-20 @90°	1 1/2	1/2	0.77
30	TS1630BS 7/8	20	1.875	2.000	B	7/8	3/16 x 3/32	(1) 1/4-20 @90°	1 1/2	1/2	0.77
32	TS1632BS 5/8	20	2.000	2.125	B	5/8	3/16 x 3/32	(1) 1/4-20 @90°	1 3/4	1/2	0.90
32	TS1632BS 3/4	20	2.000	2.125	B	3/4	3/16 x 3/32	(1) 1/4-20 @90°	1 3/4	1/2	0.90
32	TS1632BS 7/8	20	2.000	2.125	B	7/8	3/16 x 3/32	(1) 1/4-20 @90°	1 3/4	1/2	0.90
32	TS1632BS 1	20	2.000	2.125	B	1	1/4 x 1/8	(1) 5/16-18 @90°	1 3/4	1/2	0.90

Los engranes con ángulo de presión de 20° no operan con engranes con ángulo de presión de 14 1/2°.

Martin

Engranos Rectos de Acero en Existencia

Ángulo de Presión 20°

20 DP

Cara 1/2"

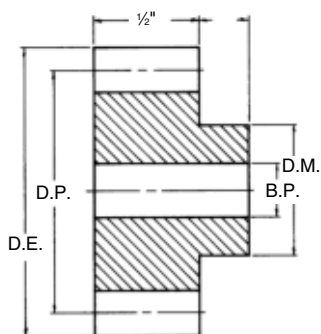

Tipo B



Tipo B
Sencillo con Maza en Acero

Acero

Número de Dientes	Número de Parte	Ángulo de Presión	Diámetro		Tipo	Barreno (Pulg.)		Maza (Pulg.)		Peso Aprox. (lb)
			Paso	Exterior		Piloto	Máx. *	Diámetro	Proy.	
12	TS2012	20	.600	.700	B	5/16	5/16	15/32	7/16	0.04
14	TS2014	20	.700	.800	B	5/16	5/16	35/64	7/16	0.06
15	TS2015	20	.750	.850	B	3/8	3/8	39/64	7/16	0.07
16	TS2016	20	.800	.900	B	3/8	3/8	21/32	7/16	0.08
18	TS2018	20	.900	1.000	B	3/8	3/8	3/4	7/16	0.12
20	TS2020	20	1.000	1.100	B	1/2	1/2	55/64	7/16	0.13
21	TS2021	20	1.050	1.150	B	1/2	1/2	7/8	7/16	0.15
22	TS2022	20	1.100	1.200	B	1/2	1/2	31/32	7/16	0.17
24	TS2024	20	1.200	1.300	B	1/2	5/16	11/16	7/16	0.22
25	TS2025	20	1.250	1.350	B	1/2	5/16	17/64	7/16	0.24
28	TS2028	20	1.400	1.500	B	1/2	11/16	11/64	7/16	0.32
30	TS2030	20	1.500	1.600	B	1/2	15/16	125/64	7/16	0.38
32	TS2032	20	1.600	1.700	B	1/2	7/8	11/16	1/2	0.46
35	TS2035	20	1.750	1.850	B	1/2	7/8	11/16	1/2	0.56
36	TS2036	20	1.800	1.900	B	1/2	15/16	11/16	1/2	0.60
40	TS2040	20	2.000	2.100	B	1/2	11/16	11/16	1/2	0.76
45	TS2045	20	2.250	2.350	B	1/2	11/16	2	1/2	0.95
50	TS2050	20	2.500	2.600	B	1/2	11/16	2	1/2	1.08
60	TS2060	20	3.000	3.100	B	1/2	11/16	21/8	1/2	1.45
70	TS2070	20	3.500	3.600	B	1/2	11/16	21/8	1/2	1.93
72	TS2072	20	3.600	3.700	B	1/2	11/16	21/8	1/2	2.01
80	TS2080	20	4.000	4.100	B	5/8	11/16	21/8	5/8	2.35
84	TS2084	20	4.200	4.300	B	5/8	11/16	21/8	5/8	2.53
90	TS2090	20	4.500	4.600	B	5/8	11/16	21/8	5/8	2.82
96	TS2096	20	4.800	4.900	B	5/8	11/16	21/8	5/8	3.14
100	TS20100	20	5.000	5.100	B	5/8	11/16	21/8	5/8	3.35
120	TS20120	20	6.000	6.100	B	5/8	11/16	21/8	5/8	4.58

* Barreno máximo recomendado con cuñero y opresor.

Barreno a la Medida

Número de Dientes	Número de Parte	Ángulo de Presión	Diámetro		Tipo	Barreno (Pulg.)		Opresor	Maza (Pulg.)		Peso Aprox. (lb)
			Paso	Exterior		Piloto	Cuñero		Diámetro	Proy.	
12	TS2012BS 5/16	20	0.600	0.700	B	5/16	NINGÚN	#35 P.H.	15/32	7/16	0.04
14	TS2014BS 5/16	20	0.700	0.800	B	5/16	NINGÚN	#35 P.H.	35/64	7/16	0.06
15	TS2015BS 3/8	20	0.750	0.850	B	3/8	NINGÚN	(1) 8-32	39/64	7/16	0.07
16	TS2016BS 3/8	20	0.800	0.900	B	3/8	NINGÚN	(1) 8-32	21/32	7/16	0.08
18	TS2018BS 3/8	20	0.900	1.000	B	3/8	NINGÚN	(1) 10-24	3/4	7/16	0.12
20	TS2020BS 1/2	20	1.000	1.100	B	1/2	NINGÚN	(1) 10-24	55/64	7/16	0.13
24	TS2024BS 1/2	20	1.200	1.300	B	1/2	NINGÚN	(1) 1/4-20	11/16	7/16	0.22
25	TS2025BS 1/2	20	1.250	1.350	B	1/2	NINGÚN	(1) 1/4-20	17/64	7/16	0.24
30	TS2030BS 1/2	20	1.500	1.600	B	1/2	NINGÚN	(1) 1/4-20	125/64	7/16	0.38
35	TS2035BS 1/2	20	1.750	1.850	B	1/2	NINGÚN	(1) 1/4-20	11/16	1/2	0.56
40	TS2040BS 1/2	20	2.000	2.100	B	1/2	NINGÚN	(1) 1/4-20	11/16	1/2	0.76
40	TS2040BS 5/8	20	2.000	2.100	B	5/8	3/16 X 3/32	(1) 1/4-20 @90°	11/16	1/2	0.76
40	TS2040BS 3/4	20	2.000	2.100	B	3/4	3/16 X 3/32	(1) 1/4-20 @90°	11/16	1/2	0.76

Los engranes con ángulo de presión de 20° no operan con engranes con ángulo de presión de 14½°.

Capacidad de Potencia HP (Aprox.) de Engranajes Rectos

Ángulo de Presión 20°



Para
Servicio Clase I (Factor de Servicio = 1.0)

Paso Diametral 4

Ángulo de Presión 20°

Cara 3½"

Número de Dientes	25 RPM		50 RPM		100 RPM		200 RPM		300 RPM		500 RPM		600 RPM		900 RPM		1200 RPM		1800 RPM	
	S	CI	S	CI	S	CI	S	CI	S	CI	S	CI	S	CI	S	CI	S	CI	S	CI
11	2.62		5.09		9.64		17.41		23.81		33.72		37.64		46.69		53.06			
12*	3.10		6.02		11.40		20.59		28.15		39.88		44.52		55.21		62.75			
13	3.62		7.03		13.30		24.03		32.86		46.55		51.97		64.45		73.25			
14*	4.07		7.91		14.98		27.06		37.00		52.41		58.51		72.57		82.48			
15*	4.57		8.88		16.80		30.35		41.51		58.80		65.64		81.41		92.53			
16*	4.97		9.67		18.30		33.05		45.20		64.03		71.47		88.64		100.75			
17	5.41		10.51		19.90		35.95		49.16		69.64		77.74		96.42					
18*	5.84		11.35		21.49		38.82		53.09		75.20		83.95		104.12					
19	6.29		12.22		23.13		41.77		57.13		80.93		90.33		112.04					
20*	6.74		13.11		24.81		44.81		61.29		86.81		96.91							
21	7.19		13.98		26.46		47.79		65.36		92.58		103.34							
22*	7.65		14.87		28.14		50.83		69.52		98.48		109.93							
24*	8.52		16.56		31.35		56.63		77.45		109.71		122.47							
25	8.96		17.41		32.95		59.52		81.39		115.30		128.70							
26	9.43		18.32		34.67		62.63		85.65		121.32		135.43							
27	9.90		19.24		36.42		65.79		89.97		127.45		142.27							
28*	10.39		20.18		38.21		69.01		94.38		133.69		149.24							
30*	11.32		22.00		41.63		75.20		102.84		145.69									
32*	12.27		23.85		45.15		81.56		111.54		158.00									
33	12.76		24.80		46.95		84.80		115.97		164.28									
35	13.79		26.81		50.74		91.66		125.35		177.56									
36*	14.30		27.79		52.61		95.03		129.96		184.10									
40*	16.40		31.87		60.32		108.95		149.00											
42	17.39		33.80		63.98		115.58		158.06											
44*	18.41		35.77		67.71		122.31		167.27											
45	18.92		36.77		69.60		125.72		171.93											
48*	20.54		39.91		75.54		136.46		186.61											
50	21.50		41.78		79.08		142.84		195.35											
52	22.52		43.77		82.85		149.65		204.66											
54	23.56		45.78		86.66		156.54		214.08											
55	24.00		46.63		88.26		159.44		218.04											
56*	24.49		47.59		90.09		162.73													
60*	26.62		51.73		97.92		176.87													
64*	28.60		55.57		105.19		190.01													
66	29.63		57.58		108.99		196.87													
70	31.65		61.50		116.41		210.27													
72*	32.55		63.26		119.73		216.28													
80*	36.76		71.43		135.21		244.23													
84	38.86		75.52		142.94		258.21													
88	40.80		79.30		150.09															
90	41.83		81.28		153.85															
96	44.92		87.29		165.23															
100	46.90		91.13		172.50															
108	50.87		98.87		187.14															
110	51.93		100.92		191.03															
112	52.88		102.76		194.50															
120	57.03		110.84		209.79															
144	54.18		105.28		199.28															
160	77.39		150.40		284.68															
200	97.58		189.64		358.95															

Las capacidades de potencia están basadas en cálculos de resistencia.

• Indica los tamaños en existencia para este paso.

Nota: 1. Las capacidades de potencia que se encuentran a la derecha de la línea gruesa no son recomendadas debido a que la velocidad lineal excede los 1000 pies por minuto. Sólo deben ser usados para interpolación.

2. Los engranes no metálicos se utilizan normalmente como el piñón motriz con engranes fabricados de acero o de hierro fundido en aplicaciones en donde la velocidad lineal exceda los 1000 pies por minuto y que no estén sujetas a cargas de impacto.



Capacidad de Potencia HP (Aprox.) de Engranajes Rectos

Ángulo de Presión 20°

Para
Servicio Clase I (Factor de Servicio = 1.0)

Paso Diametral 5

Ángulo de Presión 20°

Cara 2½"

Número de Dientes	25 RPM		50 RPM		100 RPM		200 RPM		300 RPM		500 RPM		600 RPM		900 RPM		1200 RPM		1800 RPM	
	S	CI	S	CI	S	CI	S	CI	S	CI	S	CI	S	CI	S	CI	S	CI	S	CI
11•	1.20		2.35		4.50		8.28		11.49		16.67		18.78		23.82		27.50			
12	1.42		2.78		5.32		9.79		13.59		19.71		22.21		28.17		32.53			
13•	1.66		3.25		6.21		11.43		15.86		23.01		25.93		32.88		37.97			
14•	1.87		3.66		7.00		12.87		17.86		25.90		29.19		37.02		42.75			
15•	2.10		4.10		7.85		14.44		20.04		29.06		32.75		41.53		47.96			
16	2.29		4.47		8.55		15.72		21.82		31.64		35.66		45.22		52.22			
17•	2.49		4.86		9.30		17.10		23.73		34.42		38.79		49.19		56.80			
18	2.69		5.25		10.04		18.46		25.63		37.17		41.88		53.11		61.34			
19•	2.89		5.65		10.80		19.87		27.58		40.00		45.07		57.16		66.01			
20	3.10		6.06		11.59		21.31		29.58		42.91		48.35		61.31					
21	3.31		6.46		12.36		22.73		31.55		45.76		51.56		65.39					
22•	3.52		6.87		13.15		24.18		33.56		48.67		54.85		69.55					
24•	3.92		7.66		14.65		26.93		37.39		54.22		61.10		77.49					
25	4.12		8.05		15.39		28.30		39.29		56.98		64.21		81.43					
26	4.33		8.47		16.20		29.78		41.34		59.96		67.57							
27•	4.55		8.90		17.02		31.29		43.43		62.99		70.98							
28•	4.78		9.33		17.85		32.82		45.56		66.08		74.46							
30	5.20		10.17		19.45		35.76		49.64		72.00		81.14							
32	5.64		11.03		21.09		38.79		53.84		78.09		88.00							
33•	5.87		11.47		21.93		40.33		55.98		81.19		91.49							
35	6.34		12.40		23.70		43.59		60.51		87.76		98.89							
36•	6.58		12.85		24.58		45.19		62.73		90.99									
40	7.54		14.73		28.18		51.81		71.92		104.32									
42	8.00		15.63		29.89		54.96		76.30		110.66									
44•	8.46		16.54		31.63		58.17		80.74		117.11									
45	8.70		17.00		32.51		59.79		82.99											
48•	9.44		18.45		35.29		64.89		90.08											
50	9.89		19.32		36.94		67.93		94.30											
52	10.36		20.24		38.70		71.17		98.79											
54	10.83		21.17		40.48		74.44		103.34											
55	11.03		21.56		41.23		75.82		105.25											
56•	11.26		22.01		42.08		77.39		107.42											
60	12.24		23.92		45.74		84.11		116.76											
64	13.15		25.70		49.14		90.36		125.43											
66•	13.62		26.62		50.91		93.62		129.96											
70	14.55		28.44		54.38		100.00		138.81											
72•	14.97		29.25		55.93		102.85													
80	16.90		33.03		63.16		116.15													
84	17.87		34.92		66.78		122.79													
88•	18.76		36.67		70.12		128.93													
90	19.23		37.58		71.87		132.16													
96•	20.65		40.36		77.19		141.93													
100	21.56		42.14		80.58															
108•	23.39		45.71		87.42															
110	23.88		46.67		89.24															
112•	24.31		47.51																	
120	26.23		51.25																	
144	24.91		48.68																	
160	35.59		69.54																	
200	44.87		87.69																	

Las capacidades de potencia están basadas en cálculos de resistencia.

• Indica los tamaños en existencia para este paso.

Nota: 1. Las capacidades de potencia que se encuentran a la derecha de la línea gruesa no son recomendadas debido a que la velocidad lineal excede los 1000 pies por minuto. Sólo deben ser usados para interpolación.

2. Los engranes no metálicos se utilizan normalmente como el piñón motriz con engranes fabricados de acero o de hierro fundido en aplicaciones en donde la velocidad lineal exceda los 1000 pies por minuto y que no estén sujetas a cargas de impacto.

Capacidad de Potencia HP (Aprox.) de Engranajes Rectos

Ángulo de Presión 20°



Para
Servicio Clase I (Factor de Servicio = 1.0)

Paso Diametral 6

Ángulo de Presión 20°

Cara 2"

Número de Dientes	25 RPM		50 RPM		100 RPM		200 RPM		300 RPM		500 RPM		600 RPM		900 RPM		1200 RPM		1800 RPM	
	S	CI	S	CI	S	CI	S	CI	S	CI	S	CI	S	CI	S	CI	S	CI	S	CI
11•	0.67		1.32		2.54		4.73		6.63		9.79		11.11		14.34		16.78		20.21	
12•	0.79		1.56		3.00		5.59		7.84		11.58		13.14		16.96		19.84		23.91	
13	0.93		1.82		3.50		6.52		9.15		13.51		15.34		19.80		23.16		27.91	
14•	1.04		2.05		3.94		7.35		10.31		15.21		17.27		22.29		26.08		31.42	
15•	1.17		2.30		4.43		8.24		11.56		17.07		19.37		25.01		29.26		35.25	
16•	1.28		2.50		4.82		8.97		12.59		18.58		21.10		27.23		31.85		38.38	
17	1.39		2.72		5.24		9.76		13.69		20.21		22.95		29.61		34.65			
18•	1.50		2.94		5.66		10.54		14.79		21.83		24.78		31.98		37.42			
19	1.61		3.16		6.09		11.34		15.91		23.49		26.66		34.41		40.26			
20	1.73		3.39		6.53		12.17		17.07		25.20		28.60		36.92		43.19			
21•	1.84		3.62		6.97		12.97		18.21		26.87		30.50		39.37		46.06			
22	1.96		3.85		7.41		13.80		19.37		28.59		32.45		41.88		49.00			
24•	2.19		4.29		8.26		15.38		21.57		31.85		36.15		46.65		54.59			
25	2.30		4.51		8.68		16.16		22.67		33.47		37.99		49.03					
26	2.42		4.74		9.13		17.00		23.86		35.22		39.97		51.59					
27•	2.54		4.98		9.59		17.86		25.06		37.00		41.99		54.20					
28	2.66		5.22		10.06		18.74		26.29		38.81		44.05		56.85					
30•	2.90		5.69		10.97		20.42		28.65		42.29		48.00		61.95					
32	3.15		6.17		11.89		22.14		31.07		45.86		52.06							
33•	3.27		6.42		12.36		23.02		32.31		47.69		54.13							
35	3.54		6.94		13.36		24.88		34.92		51.54		58.50							
36•	3.67		7.19		13.86		25.80		36.20		53.44		60.66							
40	4.21		8.25		15.89		29.58		41.51		61.27		69.54							
42•	4.46		8.75		16.85		31.38		44.03		64.99		73.77							
44	4.72		9.26		17.83		33.21		46.59		68.78		78.07							
45	4.85		9.52		18.33		34.13		47.89		70.70		80.25							
48•	5.27		10.33		19.90		37.05		51.98		76.73									
50	5.51		10.81		20.83		38.78		54.42		80.32									
52	5.78		11.33		21.82		40.63		57.01		84.15									
54•	6.04		11.85		22.82		42.50		59.63		88.02									
55	6.15		12.07		23.25		43.29		60.74											
56	6.28		12.32		23.73		44.18		61.99											
60•	6.83		13.39		25.79		48.02		67.38											
64•	7.33		14.39		27.70		51.59		72.38											
66•	7.60		14.91		28.71		53.45		75.00											
70	8.12		15.92		30.66		57.09		80.10											
72•	8.35		16.37		31.54		58.72		82.39											
80	9.43		18.49		35.61		66.31		93.04											
84•	9.97		19.55		37.65		70.10		98.36											
88	10.46		20.53		39.53		73.61		103.28											
90	10.73		21.04		40.52		75.45													
96•	11.52		22.60		43.52		81.03													
100	12.03		23.59		45.43		84.60													
108•	13.05		25.59		49.29		91.77													
110	13.32		26.12		50.31		93.68													
112	13.56		26.60		51.23		95.39													
120•	14.63		28.69		55.25															
144	13.89		27.25		52.49															
160	19.85		38.93		74.98															
200	25.03		49.09		94.54															

Las capacidades de potencia están basadas en cálculos de resistencia.

• Indica los tamaños en existencia para este paso.

Nota: 1. Las capacidades de potencia que se encuentran a la derecha de la línea gruesa no son recomendadas debido a que la velocidad lineal excede los 1000 pies por minuto. Sólo deben ser usados para interpolación.

2. Los engranes no metálicos se utilizan normalmente como el piñón motriz con engranes fabricados de acero o de hierro fundido en aplicaciones en donde la velocidad lineal exceda los 1000 pies por minuto y que no estén sujetas a cargas de impacto.



Capacidad de Potencia HP (Aprox.) de Engranajes Rectos

Ángulo de Presión 20°

Para
Servicio Clase I (Factor de Servicio = 1.0)

Paso Diametral 8

Ángulo de Presión 20°

Cara 1½"

Número de Dientes	25 RPM		50 RPM		100 RPM		200 RPM		300 RPM		500 RPM		600 RPM		900 RPM		1200 RPM		1800 RPM	
	S	CI	S	CI	S	CI	S	CI	S	CI	S	CI	S	CI	S	CI	S	CI	S	CI
11	0.28		0.56		1.09		2.06		2.94		4.45		5.10		6.76		8.07		10.00	
12*	0.34		0.66		1.29		2.44		3.48		5.26		6.03		7.99		9.54		11.83	
13	0.39		0.78		1.51		2.85		4.06		6.14		7.04		9.33		11.14		13.81	
14*	0.44		0.87		1.70		3.21		4.57		6.91		7.93		10.50		12.54		15.55	
15*	0.50		0.98		1.90		3.60		5.13		7.76		8.90		11.78		14.07		17.45	
16*	0.54		1.07		2.07		3.92		5.58		8.44		9.69		12.83		15.31		18.99	
17	0.59		1.16		2.25		4.26		6.07		9.18		10.53		13.95		16.66		20.66	
18*	0.64		1.25		2.43		4.61		6.56		9.92		11.38		15.07		17.99		22.31	
19*	0.68		1.35		2.62		4.96		7.06		10.67		12.24		16.22		19.36		24.01	
20*	0.73		1.45		2.81		5.32		7.57		11.45		13.13		17.40		20.77		25.76	
21	0.78		1.54		3.00		5.67		8.07		12.21		14.00		18.55		22.14			
22*	0.83		1.64		3.19		6.03		8.59		12.99		14.90		19.73		23.56			
24*	0.93		1.83		3.55		6.72		9.56		14.47		16.60		21.98		26.24			
25	0.97		1.92		3.73		7.06		10.05		15.21		17.44		23.10		27.58			
26*	1.02		2.02		3.93		7.43		10.58		16.00		18.35		24.31		29.02			
27	1.08		2.12		4.12		7.80		11.11		16.81		19.28		25.54		30.49			
28*	1.13		2.23		4.33		8.19		11.66		17.63		20.22		26.79		31.98			
30*	1.23		2.43		4.71		8.92		12.70		19.21		22.04		29.19		34.85			
32*	1.33		2.63		5.11		9.68		13.77		20.84		23.90		31.66					
33	1.39		2.73		5.31		10.06		14.32		21.67		24.85		32.92					
35	1.50		2.96		5.74		10.87		15.48		23.42		26.86		35.58					
36*	1.56		3.06		5.96		11.27		16.05		24.28		27.85		36.89					
40*	1.78		3.51		6.83		12.92		18.40		27.84		31.93		42.29					
42*	1.89		3.73		7.24		13.71		19.52		29.53		33.87		44.86					
44*	2.00		3.94		7.67		14.51		20.66		31.25		35.84		47.48					
45	2.06		4.05		7.88		14.91		21.23		32.12		36.84							
48*	2.23		4.40		8.55		16.19		23.05		34.86		39.99							
50		1.12		2.21		4.30		8.13		11.58		17.52		20.09						
52*		1.18		2.32		4.50		8.52		12.13		18.35		21.05						
54		1.23		2.42		4.71		8.91		12.69		19.20		22.02						
55		1.25		2.47		4.80		9.08		12.93		19.55		22.43						
56*		1.28		2.52		4.90		9.27		13.19		19.96		22.89						
60*		1.39		2.74		5.32		10.07		14.34		21.69		24.88						
64*		1.49		2.94		5.72		10.82		15.40		23.30								
66		1.55		3.05		5.92		11.21		15.96		24.14								
70		1.65		3.26		6.33		11.97		17.05		25.79								
72*		1.70		3.35		6.51		12.32		17.53										
80*		1.92		3.78		7.35		13.91		19.80										
84		2.03		4.00		7.77		14.70		20.93										
88*		2.13		4.20		8.16		15.44		21.98										
90		2.18		4.30		8.36		15.82		22.53										
96*		2.34		4.62		8.98		16.99		24.20										
100		2.45		4.82		9.37		17.74		25.26										
108		2.66		5.23		10.17		19.25		27.40										
110		2.71		5.34		10.38		19.65		27.97										
112*		2.76		5.44		10.57		20.01		28.48										
120*		2.98		5.87		11.40		21.58		30.72										
144*		2.83		5.57		10.83		20.50												
160*		4.04		7.96		15.47		29.28												
200		5.09		10.04		19.51		36.92												

Las capacidades de potencia están basadas en cálculos de resistencia.

• Indica los tamaños en existencia para este paso.

Nota: 1. Las capacidades de potencia que se encuentran a la derecha de la línea gruesa no son recomendadas debido a que la velocidad lineal excede los 1000 pies por minuto. Sólo deben ser usados para interpolación.

2. Los engranes no metálicos se utilizan normalmente como el piñón motriz con engranes fabricados de acero o de hierro fundido en aplicaciones en donde la velocidad lineal exceda los 1000 pies por minuto y que no estén sujetas a cargas de impacto.

Capacidad de Potencia HP (Aprox.) de Engranajes Rectos

Ángulo de Presión 20°



Para
Servicio Clase I (Factor de Servicio = 1.0)

Paso Diametral 10

Ángulo de Presión 20°

Cara 1¼"

Número de Dientes	25 RPM		50 RPM		100 RPM		200 RPM		300 RPM		500 RPM		600 RPM		900 RPM		1200 RPM		1800 RPM	
	S	CI	S	CI	S	CI	S	CI	S	CI	S	CI	S	CI	S	CI	S	CI	S	CI
11	0.15		0.30		0.59		1.13		1.62		2.49		2.87		3.88		4.70		5.95	
12•	0.18		0.36		0.70		1.33		1.91		2.94		3.40		4.58		5.55		7.04	
13	0.21		0.42		0.81		1.55		2.23		3.43		3.97		5.35		6.48		8.22	
14•	0.24		0.47		0.91		1.75		2.51		3.87		4.47		6.02		7.30		9.25	
15•	0.27		0.53		1.03		1.96		2.82		4.34		5.01		6.76		8.19		10.38	
16•	0.29		0.57		1.12		2.14		3.07		4.72		5.45		7.36		8.91		11.30	
17	0.31		0.62		1.22		2.32		3.34		5.14		5.93		8.00		9.70		12.30	
18•	0.34		0.67		1.31		2.51		3.61		5.55		6.41		8.64		10.47		13.28	
19	0.37		0.72		1.41		2.70		3.88		5.97		6.89		9.30		11.27		14.29	
20•	0.39		0.78		1.52		2.90		4.16		6.40		7.40		9.98		12.09		15.33	
21	0.42		0.83		1.62		3.09		4.44		6.83		7.89		10.64		12.89		16.35	
22•	0.44		0.88		1.72		3.29		4.72		7.26		8.39		11.32		13.71		17.39	
24•	0.50		0.98		1.91		3.66		5.26		8.09		9.35		12.61		15.28		19.37	
25•	0.52		1.03		2.01		3.85		5.53		8.50		9.82		13.25		16.05		20.36	
26•	0.55		1.08		2.12		4.05		5.82		8.95		10.34		13.94		16.89			
27	0.58		1.14		2.22		4.25		6.11		9.40		10.86		14.65		17.75			
28•	0.60		1.19		2.33		4.46		6.41		9.86		11.39		15.37		18.61			
30•	0.66		1.30		2.54		4.86		6.99		10.74		12.41		16.74		20.28			
32•	0.71		1.41		2.76		5.27		7.58		11.65		13.46		18.16		22.00			
33	0.74		1.47		2.87		5.48		7.88		12.11		14.00		18.88		22.87			
35•	0.80		1.59		3.10		5.93		8.52		13.09		15.13		20.41		24.72			
36•	0.83		1.64		3.21		6.14		8.83		13.58		15.68		21.16		25.63			
40•	0.95		1.88		3.68		7.04		10.12		15.56		17.98		24.26					
42	1.01		2.00		3.91		7.47		10.74		16.51		19.07		25.73					
44	1.07		2.12		4.14		7.91		11.36		17.47		20.19		27.23					
45•	1.10		2.18		4.25		8.13		11.68		17.96		20.75		27.99					
48•	1.19		2.36		4.61		8.82		12.68		19.49		22.52		30.38					
50•	1.25		2.47		4.83		9.24		13.27		20.41		23.57							
52	1.31		2.59		5.06		9.68		13.90		21.38		24.70							
54	1.37		2.71		5.29		10.12		14.54		22.36		25.83							
55•	1.40		2.76		5.39		10.31		14.81		22.78		26.31							
56	1.42		2.82		5.50		10.52		15.12		23.25		26.86							
60•	1.55		3.06		5.98		11.44		16.43		25.27		29.19							
64	0.80		1.58		3.08		5.90		8.47		13.03		15.05							
66	0.83		1.63		3.19		6.11		8.78		13.50		15.60							
70•	0.88		1.75		3.41		6.53		9.38		14.42		16.66							
72	0.91		1.80		3.51		6.71		9.65		14.83		17.13							
80•	1.03		2.03		3.96		7.58		10.89		16.75									
84	1.08		2.14		4.19		8.01		11.52		17.71									
88	1.14		2.25		4.40		8.41		12.09		18.59									
90•	1.17		2.31		4.51		8.62		12.39		19.06									
96	1.25		2.48		4.84		9.26		13.31											
100•	1.31		2.59		5.06		9.67		13.90											
108	1.42		2.81		5.49		10.49		15.08											
110	1.45		2.87		5.60		10.71		15.39											
112	1.48		2.92		5.70		10.90		15.67											
120	1.59		3.15		6.15		11.76		16.90											
144	1.51		2.99		5.84		11.17		16.05											
160	2.16		4.27		8.35		15.96		22.93											
200	2.72		5.38		10.52		20.12		28.92											

Las capacidades de potencia están basadas en cálculos de resistencia.

• Indica los tamaños en existencia para este paso.

Nota: 1. Las capacidades de potencia que se encuentran a la derecha de la línea gruesa no son recomendadas debido a que la velocidad lineal excede los 1000 pies por minuto. Sólo deben ser usados para interpolación.

2. Los engranes no metálicos se utilizan normalmente como el piñón motriz con engranes fabricados de acero o de hierro fundido en aplicaciones en donde la velocidad lineal exceda los 1000 pies por minuto y que no estén sujetas a cargas de impacto.



Capacidad de Potencia HP (Aprox.) de Engranajes Rectos

Ángulo de Presión 20°

Para
Servicio Clase I (Factor de Servicio = 1.0)

Paso Diametral 12

Ángulo de Presión 20°

Cara 1"

Número de Dientes	25 RPM		50 RPM		100 RPM		200 RPM		300 RPM		500 RPM		600 RPM		900 RPM		1200 RPM		1800 RPM	
	S	CI	S	CI	S	CI	S	CI	S	CI	S	CI	S	CI	S	CI	S	CI	S	CI
11	0.08		0.17		0.33		0.63		0.92		1.43		1.66		2.27		2.78		3.58	
12•	0.10		0.20		0.39		0.75		1.09		1.69		1.96		2.68		3.28		4.24	
13•	0.12		0.23		0.45		0.88		1.27		1.97		2.29		3.13		3.83		4.95	
14•	0.13		0.26		0.51		0.99		1.43		2.22		2.58		3.52		4.32		5.57	
15•	0.15		0.29		0.57		1.11		1.60		2.49		2.89		3.95		4.84		6.25	
16•	0.16		0.32		0.63		1.20		1.74		2.71		3.15		4.30		5.27		6.81	
17	0.18		0.35		0.68		1.31		1.90		2.95		3.42		4.68		5.74		7.40	
18•	0.19		0.37		0.73		1.42		2.05		3.18		3.70		5.06		6.19		7.99	
19•	0.20		0.40		0.79		1.52		2.20		3.43		3.98		5.44		6.67		8.60	
20•	0.22		0.43		0.85		1.63		2.36		3.68		4.27		5.84		7.15		9.23	
21•	0.23		0.46		0.90		1.74		2.52		3.92		4.55		6.22		7.63		9.84	
22•	0.25		0.49		0.96		1.85		2.68		4.17		4.84		6.62		8.11		10.47	
24•	0.28		0.55		1.07		2.06		2.99		4.64		5.39		7.38		9.04		11.66	
25•	0.29		0.57		1.13		2.17		3.14		4.88		5.67		7.75		9.50		12.26	
26•	0.31		0.60		1.19		2.28		3.30		5.14		5.96		8.16		9.99		12.90	
27	0.32		0.63		1.25		2.40		3.47		5.40		6.27		8.57		10.50		13.55	
28•	0.34		0.67		1.31		2.52		3.64		5.66		6.57		8.99		11.01		14.21	
30•	0.37		0.73		1.42		2.74		3.96		6.17		7.16		9.79		12.00		15.49	
32•	0.40		0.79		1.54		2.97		4.30		6.69		7.77		10.62		13.01			
33	0.41		0.82		1.61		3.09		4.47		6.95		8.08		11.05		13.53			
35	0.45		0.88		1.73		3.34		4.83		7.52		8.73		11.94		14.63			
36•	0.46		0.92		1.80		3.46		5.01		7.79		9.05		12.38		15.16			
40	0.53		1.05		2.06		3.97		5.74		8.94		10.38		14.19		17.39			
42•	0.56		1.12		2.19		4.21		6.09		9.48		11.01		15.05		18.44			
44	0.60		1.18		2.32		4.46		6.45		10.03		11.65		15.93		19.52			
45	0.61		1.21		2.38		4.58		6.63		10.31		11.97		16.37		20.06			
48•	0.66		1.32		2.58		4.97		7.19		11.19		13.00		17.77					
50	0.70		1.38		2.70		5.21		7.53		11.71		13.60		18.60					
52	0.73		1.44		2.83		5.45		7.89		12.27		14.25		19.49					
54•	0.76		1.51		2.96		5.71		8.25		12.84		14.91		20.39					
55	0.78		1.54		3.02		5.81		8.41		13.08		15.18		20.77					
56	0.79		1.57		3.08		5.93		8.58		13.35		15.50		21.19					
60•	0.86		1.71		3.35		6.45		9.33		14.51		16.84		23.04					
64	0.93		1.83		3.60		6.93		10.02		15.58		18.10		24.75					
66•	0.96		1.90		3.73		7.18		10.38		16.15		18.75							
70	1.02		2.03		3.98		7.66		11.09		17.24		20.03							
72•	1.05		2.09		4.09		7.88		11.40											
80		0.57		1.13		2.22		4.27		6.18		9.61		11.16						
84•		0.60		1.20		2.35		4.52		6.53		10.16		11.80						
88		0.63		1.26		2.46		4.74		6.86		10.67		12.39						
90		0.65		1.29		2.52		4.86		7.03		10.94								
96•		0.70		1.38		2.71		5.22		7.55		11.75								
100		0.73		1.44		2.83		5.45		7.89		12.27								
108•		0.79		1.57		3.07		5.91		8.55		13.31								
110		0.81		1.60		3.13		6.04		8.73		13.58								
112		0.82		1.63		3.19		6.15		8.89										
120•		0.89		1.76		3.44		6.63		9.59										
144•		0.84		1.67		3.27		6.30		9.11										
160		1.20		2.38		4.67		9.00		13.01										
200		1.52		3.00		5.89		11.34		16.41										

Las capacidades de potencia están basadas en cálculos de resistencia.

• Indica los tamaños en existencia para este paso.

Nota: 1. Las capacidades de potencia que se encuentran a la derecha de la línea gruesa no son recomendadas debido a que la velocidad lineal excede los 1000 pies por minuto. Sólo deben ser usados para interpolación.

2. Los engranes no metálicos se utilizan normalmente como el piñón motriz con engranes fabricados de acero o de hierro fundido en aplicaciones en donde la velocidad lineal exceda los 1000 pies por minuto y que no estén sujetas a cargas de impacto.

Capacidad de Potencia HP (Aprox.) de Engranajes Rectos

Ángulo de Presión 20°



Para
Servicio Clase I (Factor de Servicio = 1.0)

Paso Diametral 16

Ángulo de Presión 20°

Cara ¼"

Número de Dientes	25 RPM		50 RPM		100 RPM		200 RPM		300 RPM		500 RPM		600 RPM		900 RPM		1200 RPM		1800 RPM	
	S	CI	S	CI	S	CI	S	CI	S	CI	S	CI	S	CI	S	CI	S	CI	S	CI
11	0.04		0.07		0.14		0.27		0.40		0.63		0.73		1.02		1.28		1.69	
12•	0.04		0.08		0.17		0.32		0.47		0.74		0.87		1.21		1.51		2.00	
13•	0.05		0.10		0.19		0.38		0.55		0.87		1.01		1.41		1.76		2.33	
14•	0.06		0.11		0.22		0.42		0.62		0.98		1.14		1.59		1.98		2.63	
15•	0.06		0.12		0.24		0.48		0.69		1.10		1.28		1.79		2.22		2.95	
16•	0.07		0.14		0.27		0.52		0.76		1.19		1.40		1.94		2.42		3.21	
17•	0.07		0.15		0.29		0.56		0.82		1.30		1.52		2.12		2.63		3.49	
18•	0.08		0.16		0.31		0.61		0.89		1.40		1.64		2.28		2.84		3.77	
19	0.09		0.17		0.34		0.65		0.95		1.51		1.76		2.46		3.06		4.05	
20•	0.09		0.18		0.36		0.70		1.02		1.62		1.89		2.64		3.28		4.35	
21•	0.10		0.20		0.39		0.75		1.09		1.73		2.02		2.81		3.50		4.64	
22•	0.10		0.21		0.41		0.80		1.16		1.84		2.15		2.99		3.72		4.93	
24•	0.12		0.23		0.46		0.89		1.29		2.04		2.39		3.33		4.15		5.50	
25	0.12		0.24		0.48		0.93		1.36		2.15		2.51		3.50		4.36		5.78	
26•	0.13		0.26		0.50		0.98		1.43		2.26		2.64		3.69		4.59		6.08	
27	0.14		0.27		0.53		1.03		1.50		2.38		2.78		3.87		4.82		6.38	
28•	0.14		0.28		0.56		1.08		1.58		2.49		2.91		4.06		5.06		6.70	
30•	0.15		0.31		0.61		1.18		1.72		2.72		3.18		4.43		5.51		7.30	
32•	0.17		0.33		0.66		1.28		1.86		2.94		3.44		4.80		5.98		7.91	
33	0.17		0.35		0.68		1.33		1.94		3.06		3.58		4.99		6.21		8.23	
35	0.19		0.37		0.74		1.44		2.09		3.31		3.87		5.39		6.72		8.89	
36•	0.20		0.39		0.77		1.49		2.17		3.43		4.01		5.59		6.96		9.22	
40•	0.22		0.45		0.88		1.71		2.49		3.93		4.60		6.41		7.98		10.57	
42	0.24		0.47		0.93		1.81		2.64		4.17		4.88		6.80		8.47			
44	0.25		0.50		0.99		1.92		2.80		4.42		5.16		7.20		8.96			
45	0.26		0.51		1.01		1.97		2.87		4.54		5.31		7.40		9.21			
48•	0.28		0.56		1.10		2.14		3.12		4.93		5.76		8.03		10.00			
50	0.29		0.58		1.15		2.24		3.26		5.16		6.03		8.41		10.47			
52	0.31		0.61		1.21		2.34		3.42		5.40		6.32		8.81		10.96			
54	0.32		0.64		1.26		2.45		3.58		5.65		6.61		9.21		11.47			
55	0.33		0.65		1.29		2.50		3.64		5.76		6.73		9.38		11.68			
56•	0.34		0.67		1.31		2.55		3.72		5.88		6.87		9.58					
60•	0.36		0.72		1.43		2.77		4.04		6.39		7.47		10.41					
64•	0.39		0.78		1.53		2.98		4.34		6.86		8.02		11.18					
66	0.41		0.81		1.59		3.08		4.50		7.11		8.31		11.58					
70	0.43		0.86		1.70		3.29		4.81		7.59		8.88		12.37					
72•	0.45		0.88		1.74		3.39		4.94		7.81		9.13		12.73					
80•	0.50		1.00		1.97		3.83		5.58		8.82		10.31		14.37					
84•	0.53		1.06		2.08		4.05		5.90		9.32		10.90		15.19					
88•	0.56		1.11		2.19		4.25		6.20		9.79		11.45							
90	0.57		1.14		2.24		4.35		6.35		10.03		11.73							
96•	0.62		1.22		2.41		4.68		6.82		10.78		12.60							
100	0.64		1.27		2.51		4.88		7.12		11.25		13.16							
108		0.33		0.66		1.31		2.54		3.71		5.86		6.85						
110		0.34		0.68		1.34		2.60		3.79		5.98		6.99						
112•		0.35		0.69		1.36		2.64		3.85		6.09		7.12						
120		0.37		0.74		1.47		2.85		4.16		6.57		7.68						
144•		0.36		0.71		1.39		2.71		3.95		6.24								
160•		0.51		1.01		1.99		3.87		5.64		8.91								
200		0.64		1.27		2.51		4.88		7.11		11.24								

Las capacidades de potencia están basadas en cálculos de resistencia.

• Indica los tamaños en existencia para este paso.

Nota: 1. Las capacidades de potencia que se encuentran a la derecha de la línea gruesa no son recomendadas debido a que la velocidad lineal excede los 1000 pies por minuto. Sólo deben ser usados para interpolación.

2. Los engranes no metálicos se utilizan normalmente como el piñón motriz con engranes fabricados de acero o de hierro fundido en aplicaciones en donde la velocidad lineal exceda los 1000 pies por minuto y que no estén sujetas a cargas de impacto.



Capacidad de Potencia HP (Aprox.) de Engranajes Rectos

Ángulo de Presión 20°

Para
Servicio Clase I (Factor de Servicio = 1.0)

Paso Diametral 20

Ángulo de Presión 20°

Cara 1/2"

Número de Dientes	25 RPM		50 RPM		100 RPM		200 RPM		300 RPM		500 RPM		600 RPM		900 RPM		1200 RPM		1800 RPM	
	S	CI	S	CI	S	CI	S	CI	S	CI	S	CI	S	CI	S	CI	S	CI	S	CI
11	0.02		0.03		0.06		0.12		0.17		0.28		0.32		0.46		0.57		0.78	
12*	0.02		0.04		0.07		0.14		0.20		0.33		0.38		0.54		0.68		0.92	
13	0.02		0.04		0.08		0.16		0.24		0.38		0.45		0.63		0.79		1.07	
14*	0.02		0.05		0.09		0.18		0.27		0.43		0.50		0.71		0.89		1.20	
15*	0.03		0.05		0.11		0.21		0.30		0.48		0.56		0.80		1.00		1.35	
16*	0.03		0.06		0.11		0.22		0.33		0.52		0.61		0.87		1.09		1.47	
17	0.03		0.06		0.12		0.24		0.36		0.57		0.67		0.94		1.19		1.60	
18*	0.03		0.07		0.13		0.26		0.38		0.61		0.72		1.02		1.28		1.73	
19	0.04		0.07		0.14		0.28		0.41		0.66		0.78		1.10		1.38		1.86	
20*	0.04		0.08		0.16		0.30		0.44		0.71		0.83		1.18		1.48		2.00	
21*	0.04		0.08		0.17		0.32		0.47		0.76		0.89		1.25		1.58		2.13	
22*	0.04		0.09		0.18		0.34		0.50		0.80		0.94		1.33		1.68		2.26	
24*	0.05		0.10		0.20		0.38		0.56		0.90		1.05		1.49		1.87		2.52	
25*	0.05		0.10		0.21		0.40		0.59		0.94		1.11		1.56		1.96		2.65	
26	0.06		0.11		0.22		0.42		0.62		0.99		1.16		1.64		2.07		2.79	
27	0.06		0.12		0.23		0.44		0.65		1.04		1.22		1.73		2.17		2.93	
28*	0.06		0.12		0.24		0.47		0.68		1.09		1.28		1.81		2.28		3.07	
30*	0.07		0.13		0.26		0.51		0.75		1.19		1.40		1.97		2.48		3.35	
32*	0.07		0.14		0.28		0.55		0.81		1.29		1.52		2.14		2.69		3.63	
33	0.07		0.15		0.29		0.57		0.84		1.34		1.58		2.22		2.80		3.78	
35*	0.08		0.16		0.32		0.62		0.91		1.45		1.70		2.40		3.03		4.08	
36*	0.08		0.17		0.33		0.64		0.94		1.50		1.77		2.49		3.14		4.23	
40*	0.10		0.19		0.38		0.74		1.08		1.72		2.02		2.86		3.60		4.85	
42	0.10		0.20		0.40		0.78		1.15		1.83		2.15		3.03		3.81		5.15	
44	0.11		0.21		0.42		0.83		1.21		1.93		2.27		3.21		4.04		5.45	
45*	0.11		0.22		0.44		0.85		1.25		1.99		2.34		3.30		4.15		5.60	
48	0.12		0.24		0.47		0.92		1.35		2.16		2.54		3.58		4.50		6.08	
50*	0.13		0.25		0.49		0.97		1.42		2.26		2.65		3.75		4.71		6.36	
52	0.13		0.26		0.52		1.01		1.48		2.37		2.78		3.92		4.94		6.66	
54	0.14		0.27		0.54		1.06		1.55		2.48		2.91		4.10		5.17			
55	0.14		0.28		0.55		1.08		1.58		2.52		2.96		4.18		5.26			
56	0.14		0.28		0.56		1.10		1.61		2.57		3.02		4.27		5.37			
60*	0.16		0.31		0.61		1.20		1.75		2.80		3.29		4.64		5.84			
64	0.17		0.33		0.66		1.28		1.88		3.01		3.53		4.98		6.27			
66	0.17		0.34		0.68		1.33		1.95		3.11		3.66		5.16		6.50			
70*	0.19		0.37		0.73		1.42		2.08		3.33		3.91		5.51		6.94			
72*	0.19		0.38		0.75		1.46		2.14		3.42		4.02		5.67		7.14			
80*	0.22		0.43		0.85		1.65		2.42		3.86		4.54		6.40					
84*	0.23		0.45		0.89		1.75		2.56		4.08		4.80		6.77					
88	0.24		0.47		0.94		1.83		2.69		4.29		5.04		7.11					
90*	0.24		0.49		0.96		1.88		2.76		4.40		5.16		7.29					
96*	0.26		0.52		1.03		2.02		2.96		4.72		5.55		7.83					
100*	0.27		0.55		1.08		2.11		3.09		4.93		5.79		8.17					
108	0.30		0.59		1.17		2.29		3.35		5.35		6.28							
110	0.30		0.60		1.19		2.33		3.42		5.46		6.41							
112	0.31		0.62		1.22		2.38		3.48		5.56		6.53							
120*	0.33		0.66		1.31		2.56		3.76		5.99		7.04							
144	0.32		0.63		1.25		2.43		3.57		5.69		6.69							
160	0.45		0.90		1.78		3.48		5.10		8.13		9.56							
200	0.57		1.14		2.24		4.38		6.43		10.26		12.05							

Las capacidades de potencia están basadas en cálculos de resistencia.

• Indica los tamaños en existencia para este paso.

Nota: 1. Las capacidades de potencia que se encuentran a la derecha de la línea gruesa no son recomendadas debido a que la velocidad lineal excede los 1000 pies por minuto. Sólo deben ser usados para interpolación.

2. Los engranes no metálicos se utilizan normalmente como el piñón motriz con engranes fabricados de acero o de hierro fundido en aplicaciones en donde la velocidad lineal exceda los 1000 pies por minuto y que no estén sujetas a cargas de impacto.

Cremalleras Maquinadas



Ancho de Cara Estándar Acero — Ángulo de Presión de 14½° y de 20°

Número de Parte		Paso	Ancho de Cara (Pulgadas)	Espesor Total (Pulgadas)	Línea de Paso	Peso Aprox. lb/Pz.
A.P. 14½°	A.P. 20°					
R3x2	TR3x2	3	3	1½	1.167	24.0
R3x4	TR3x4	3	3	1½	1.167	48.0
R3x6	TR3x6	3	3	1½	1.167	72.0
R4x2	TR4x2	4	2	1½	1.250	17.4
R4x4	TR4x4	4	2	1½	1.250	34.8
R4x6	TR4x6	4	2	1½	1.250	52.2
RA4x2		4	2	2	1.750	23.6
RA4x4		4	2	2	1.750	47.2
RA4x6		4	2	2	1.750	70.8
R5x2	TR5x2	5	1¾	1¼	1.050	12.8
R5x4	TR5x4	5	1¾	1¼	1.050	25.6
R5x6	TR5x6	5	1¾	1¼	1.050	38.4
RA5x2		5	1¾	1½	1.300	16.0
RA5x4		5	1¾	1½	1.300	32.0
RA5x6		5	1¾	1½	1.300	48.0
R6x2		6	1½	1	.833	8.6
R6x4		6	1½	1	.833	17.2
R6x6		6	1½	1	.833	25.8
RA6x2	TR6x2	6	1½	1½	1.333	13.8
RA6x4	TR6x4	6	1½	1½	1.333	27.6
RA6x6	TR6x6	6	1½	1½	1.333	41.4
R8x2		8	1¼	¾	.625	5.2
R8x4		8	1¼	¾	.625	10.4
R8x6		8	1¼	¾	.625	15.6
RA8x2	TR8x2	8	1¼	1¼	1.125	9.8
RA8x4	TR8x4	8	1¼	1¼	1.125	19.6
RA8x6	TR8x6	8	1¼	1¼	1.125	29.4
R10x2		10	1	¾	.525	3.6
R10x4		10	1	¾	.525	7.2
R10x6		10	1	¾	.525	10.8
RA10x2	TR10x2	10	1	1	.900	6.0
RA10x4	TR10x4	10	1	1	.900	12.0
RA10x6	TR10x6	10	1	1	.900	18.0
R12x2		12	¾	½	.417	2.0
R12x4		12	¾	½	.417	4.0
R12x6		12	¾	½	.417	6.0
RA12x2	TR12x2	12	¾	¾	.667	3.4
RA12x4	TR12x4	12	¾	¾	.667	6.8
RA12x6	TR12x6	12	¾	¾	.667	10.2
R16x2		16	⅝	⅝	.250	.50
R16x4		16	⅝	⅝	.250	1.00
R16x6		16	⅝	⅝	.250	1.50
RA16x2	TR16x2	16	½	½	.438	1.52
RA16x4	TR16x4	16	½	½	.438	3.04
RA16x6	TR16x6	16	½	½	.438	4.56
R20x2	TR20x2	20	¾	¾	.325	.84
R20x4	TR20x4	20	¾	¾	.325	1.68
R20x6	TR20x6	20	¾	¾	.325	2.52
R24x2		24	¾	¾	.208	.38
R24x4		24	¾	¾	.208	.76
R24x6		24	¾	¾	.208	1.14

Las cremalleras *Martin* están fabricadas en acero de bajo carbón. Están disponibles con ángulos de presión de 14½° y 20° y en longitudes de 2, 4 y 6 pies. Al fabricar se les da tolerancias para corte y maquinado. Los piñones que trabajan con estas cremalleras se seleccionan en la sección de engranes rectos de este catálogo. Se pueden suministrar cremalleras en otro tipo de materiales, pasos y tamaños.

Ancho de Cara Amplio Acero — Ángulo de Presión de 20°

Número de Parte	Paso	Ancho de Cara (Pulgadas)	Espesor Total (Pulgadas)	Línea de Paso	Peso Aprox. Lb/Pz.
R204x2	4	3½	2	1.750	41.0
R204x4	4	3½	2	1.750	82.0
R204x6	4	3½	2	1.750	123.0
R205x2	5	2½	1½	1.300	22.4
R205x4	5	2½	1½	1.300	44.8
R205x6	5	2½	1½	1.300	67.2
R206x2	6	2	1½	1.333	17.0
R206x4	6	2	1½	1.333	34.0
R206x6	6	2	1½	1.333	51.0
R208x2	8	1½	1½	1.375	13.8
R208x4	8	1½	1½	1.375	27.6
R208x6	8	1½	1½	1.375	41.3
R2010x2	10	1¼	1¼	1.150	9.0
R2010x4	10	1¼	1¼	1.150	18.0
R2010x6	10	1¼	1¼	1.150	27.0
R2012x2	12	1	1	.917	6.4
R2012x4	12	1	1	.917	12.8
R2012x6	12	1	1	.917	19.2
R2016x2	16	¾	¾	.688	3.4
R2016x4	16	¾	¾	.688	6.8
R2016x6	16	¾	¾	.688	10.2
R2020x2	20	½	½	.450	.8
R2020x4	20	½	½	.450	1.6
R2020x6	20	½	½	.450	2.5

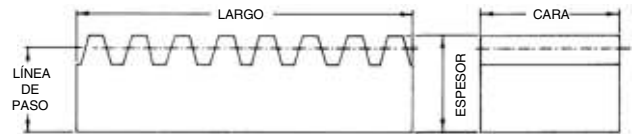

Martin Tiene en Existencia
Engranés
Rectos de 14½° y de 20°

Engranés Cónicos Rectos

Ángulo de Presión 20°

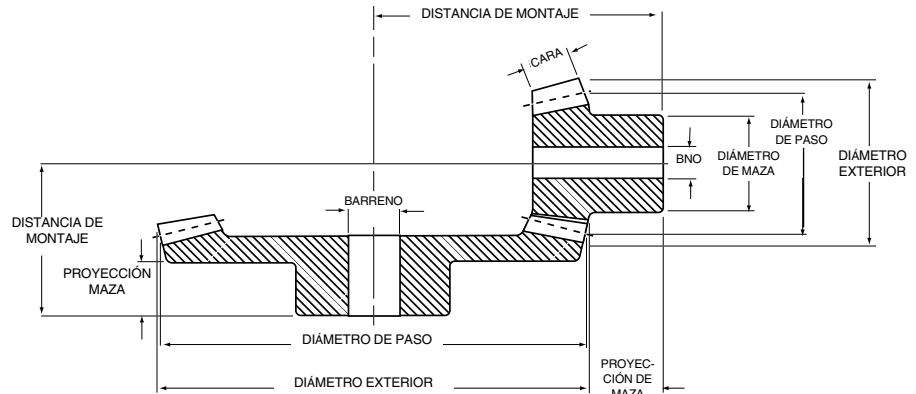

Los engranes cónicos rectos se utilizan como transmisiones en ángulo recto en donde se requiere una gran eficiencia. Se encuentran disponibles en existencia con relaciones de velocidad de 1:1 a 6:1. Los engranes cónicos rectos se cortan con el sistema de adendum largo y corto y con ángulo de presión de 20° para compensar el subcorte en engranes y piñones con número de dientes bajo. Todos

los engranes cónicos *Martin* se cortan con la forma de diente Coniflex, lo que permite un ligero desalineamiento durante la operación del ensamble. Estos engranes deben instalarse en la distancia correcta entre los centros del ápice utilizando rodamientos de empuje en la parte posterior de las mazas para absorber el empuje creado por este tipo de engrane.

Engranés de Hierro Fundido con Piñones de Acero

No. de Dientes	Número de Parte	Diámetro		Cara (Pulg.)	Barreno (Pulg.)		Montaje (Pulg.)	Maza (Pulg.)		Peso Aprox. (lb)
		Paso	Exterior		Diámetro	Largo		Diámetro	Proy. (lb)	

Paso 3

30	B330-2	10.00	10.19	1.87	1 1/4	3 3/8	5 1/2	5	2	32.8
15	B315-2	5.00	5.80	1.87	1 1/8	4 1/2	7 1/4	3 3/4	1 1/8	13.4

Paso 4

32	B432-2	8.00	8.10	1.40	1 1/8	2 11/16	4 1/4	3 3/4	1 1/8	14.7
16	B416-2	4.00	4.60	1.40	1 1/8	3 1/2	6	3 3/4	1 1/8	7.5
42	B442-3	10.50	10.59	1.42	1 1/8	2 11/16	4	3 3/4	1 1/2	20.5
14	B414-3	3.50	4.17	1.42	1 1/8	3 7/8	7 1/4	3 3/4	1 1/8	6.8
56	B456-4	14.00	14.07	1.69	1 1/4	2 7/8	4 1/4	4 1/4	1 1/8	37.8
14	B414-4	3.50	4.20	1.69	1 1/8	3 3/4	9	3 3/4	1 1/8	7.6

Paso 5

30	B530-2	6.00	6.12	1.04	1 1/8	2 1/4	3 3/4	3 3/4	1 1/8	8.6
15	B515-2	3.00	3.48	1.04	1	2 5/8	4 3/4	2 3/4	1 1/2	3.1
45	B545-3	9.00	9.07	1.31	1 1/4	2 1/2	3 3/4	3 3/4	1 1/8	14.6
15	B515-3	3.00	3.54	1.31	1	2 11/16	5 1/4	2 3/4	1 1/8	3.6
60	B560-4	12.00	12.05	1.70	1 1/4	2 3/4	3 3/4	4	1 1/8	23.2
15	B515-4	3.00	3.56	1.70	1	3 1/4	7 1/2	3	1 1/8	5.0

Paso 6

36	BS636-2	6.00	6.10	1.06	1 1/8	2 1/4	3 3/4	3 3/4	1 1/2	7.5
18	B618-2	3.00	3.42	1.06	1	2 9/16	4 3/4	2 1/2	1 1/2	3.3
42	B642-2	7.00	7.10	1.05	1 1/8	2 3/4	3 3/4	3 3/4	1 1/2	9.5
21	B621-2	3.50	3.90	1.05	1	2 3/4	5	2 1/2	1 1/4	3.8
45	B645-3	7.50	7.56	1.07	1 1/8	2 1/4	3	3 3/4	1 1/8	8.9
15	B615-3	2.50	2.94	1.07	7/8	2 1/8	5 1/4	2 1/2	1 1/8	2.2
48	B648-2	8.00	8.10	1.17	1 1/8	1 7/8	3 1/2	3 3/4	1	11.6
24	B624-2	4.00	4.40	1.17	1	2 3/4	5 1/2	2 3/4	1 1/4	4.9
60	B660-4	10.00	10.04	1.21	1 1/8	2 1/4	3 3/4	3 3/4	1 1/8	14.3
15	B615-4	2.50	2.97	1.21	1	2 31/32	6 3/4	2 1/2	1 1/4	3.2

Los engranes cónicos de acero pueden ser suministrados con dientes endurecidos con un leve costo adicional.

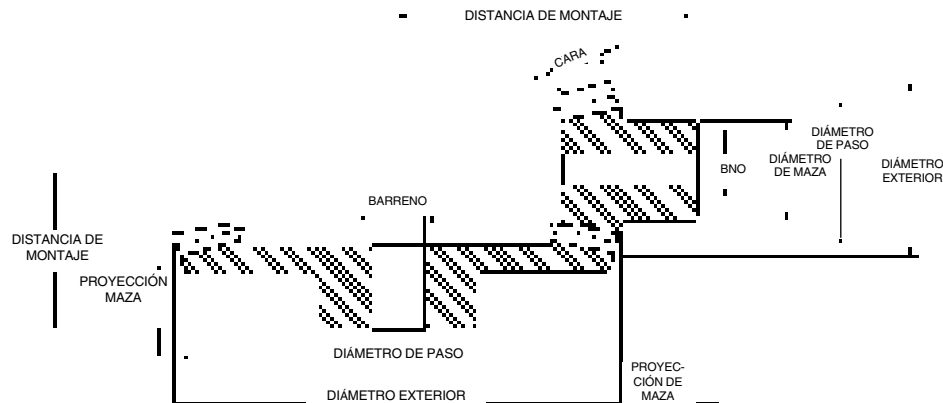

Engranés de Hierro Fundido con Piñones de Acero

No. de Dientes	Número de Parte	Diámetro		Cara (Pulg.)	Barreno (Pulg.)		Montaje (Pulg.)	Maza (Pulg.)		Peso Aprox. (lb)
		Paso	Exterior		Diámetro	Largo		Diámetro	Proy. (lb)	

Paso 8

40	BS840-2	5.00	5.07	.82	1	1 ⁷ / ₃₂	2 ⁷ / ₈	3	1 ¹ / ₄	4.9
20	B820-2	2.50	2.80	.82	⁷ / ₈	2 ⁷ / ₃₂	4	2 ⁷ / ₈	1 ¹ / ₃₂	1.9
48	B848-3	6.05	6.20	.84	⁷ / ₈	1 ¹ / ₈	2 ³ / ₈	2 ³ / ₄	1	4.5
16	B816-3	2.00	2.33	.84	³ / ₄	2 ³ / ₄	4 ¹ / ₄	1 ³ / ₄	1 ³ / ₁₆	1.2
64	B864-4	8.00	8.03	.84	1	1 ¹ / ₈	2 ³ / ₄	2 ³ / ₄	1 ¹ / ₄	9.0
16	B816-4	2.00	2.35	.84	⁷ / ₈	2 ⁷ / ₃₂	5 ¹ / ₄	1 ¹ / ₈	1 ¹ / ₃₂	1.3
72	B872-4	9.00	9.03	1.22	1 ¹ / ₈	2 ⁷ / ₁₆	3 ¹ / ₄	3	1 ¹ / ₁₆	12.2
18	B818-4	2.25	2.60	1.22	⁷ / ₈	2 ⁷ / ₃₂	5 ¹ / ₄	2 ⁷ / ₈	1 ¹ / ₁₆	1.9

Paso 10

60	B1060-3	6.00	6.04	.78	⁷ / ₈	1 ²⁹ / ₃₂	2 ³ / ₄	3	1 ³ / ₈	5.1
20	B1020-3	2.00	2.27	.78	³ / ₄	2 ³ / ₃₂	4 ³ / ₈	1 ³ / ₄	1 ¹ / ₁₆	1.3
60	B1060-4	6.00	6.03	.72	⁷ / ₈	1 ¹ / ₈	2 ¹ / ₄	2 ¹ / ₂	1 ¹ / ₈	4.5
15	B1015-4	1.50	1.78	.72	⁵ / ₈	1 ³ / ₄	3 ³ / ₈	1 ¹ / ₁₆	²⁷ / ₃₂	.6
90	B1090-6	9.00	9.03	.86	1	1 ¹³ / ₁₆	2 ¹ / ₂	2 ³ / ₄	1 ³ / ₁₆	9.7
15	B1015-6	1.50	1.79	.86	⁵ / ₈	1 ⁵ / ₄	5 ¹ / ₂	1 ¹ / ₁₆	³¹ / ₃₂	.7

Paso 12

36	B1236-2	3.00	3.05	.46	⁵ / ₈	⁷ / ₈	1 ¹ / ₂	1 ¹ / ₁₆	¹ / ₂	.8
18	B1218-2	1.50	1.70	.46	¹ / ₂	1 ¹³ / ₆₄	2 ¹ / ₄	1 ¹ / ₄	¹¹ / ₁₆	.5
72	B1272-4	6.00	6.02	.60	³ / ₄	1 ¹ / ₁₆	2	2	⁶ / ₆₄	2.6
18	B1218-4	1.50	1.73	.60	¹ / ₂	1 ²³ / ₆₄	3 ³ / ₄	1 ¹ / ₄	²³ / ₃₂	.4
72	B1272-6	6.00	6.02	.74	³ / ₄	1 ¹ / ₁₆	1 ³ / ₄	2	⁶ / ₆₄	2.6
12	B1212-6	1.00	1.24	.74	¹ / ₂	1 ³¹ / ₆₄	3 ³ / ₄	¹⁵ / ₁₆	²³ / ₃₂	.4

Los engranes cónicos de acero pueden ser suministrados con dientes endurecidos con un leve costo adicional.

Engranés Cónicos Rectos

Ángulo de Presión 20°



Engranés de Acero con Piñones de Acero

No. de Dientes	Número de Parte	Diámetro		Cara (Pulg.)	Barreno (Pulg.)		Montaje (Pulg.)	Maza (Pulg.)		Peso Aprox. (lb)
		Paso	Exterior		Diámetro	Largo		Diámetro	Proy. (lb)	

Paso 6

36	BS636-2	6.00	6.10	1.06	1 1/2	2 1/4	3 1/2	3 3/4	1 1/2	8.7
18	BS618-2	3.00	3.42	1.06	1 1/2	2 3/64	4 3/4	2 1/2	1 1/2	3.2

Paso 8

40	BS840-2	5.00	5.07	.82	1	1 27/32	2 1/2	3	1 1/4	4.9
20	BS820-2	2.50	2.80	.82	1	2 5/32	4	2 1/2	1 1/2	1.8

Paso 10

30	BS1030-15	3.00	3.08	.57	3/4	1 1/16	2 1/4	2 1/2	1	2.0
20	BS1020-15	2.00	2.21	.57	3/4	1 39/64	2 1/2	1 1/4	2 1/2	.8
40	BS1040-2	4.00	4.06	.71	7/8	1 11/16	2 1/2	3	1 1/16	3.7
20	BS1020-2	2.00	2.24	.71	3/4	1 51/64	3 3/4	1 1/4	1 1/16	1.0
50	BS1050-2	5.00	5.06	.70	3/4	1 19/32	2 1/2	2	1	4.0
25	B1025-2	2.50	2.74	.70	3/4	1 35/64	3 3/4	2	3/4	1.5
60	BS1060-3	6.00	6.04	.78	1	1 55/64	2 1/4	3	1 1/8	6.0
20	BS1020-3	2.00	2.27	.78	7/8	2 5/32	4 3/4	1 1/4	1 1/16	.9

Paso 12

27	BS1227-15	2.25	2.32	.41	1/2	1 1/8	1 1/4	1 1/2	2 1/2	.6
18	BS1218-15	1.50	1.67	.41	1/2	1 1/8	1 1/4	1 1/4	2 1/2	.3
36	BS1236-2	3.00	3.05	.53	1	1 17/64	1 1/4	2 1/2	7/8	1.3
18	BS1218-2	1.50	1.70	.53	3/4	1 1/8	2 1/2	1 3/16	1 3/16	.3
36	BS1236-2A	3.00	3.05	.53	5/8	1 17/64	1 1/4	2 1/2	7/8	1.4
18	BS1218-2A	1.50	1.70	.53	1/2	1 1/8	2 1/2	1 3/16	1 3/16	.4
48	BS1248-2	4.00	4.05	.59	5/8	1 11/64	2	1 1/4	3/4	1.6
24	B1224-2	2.00	2.20	.59	1/2	1 1/8	2 1/2	1 1/2	3/4	.8
54	BS1254-3	4.50	4.53	.60	5/8	1 1/8	1 1/4	1 1/4	3/4	1.9
18	B1218-3	1.50	1.72	.60	1/2	1 11/32	3	1 1/4	1 1/16	.4

Paso 14

28	BS1428-2	2.00	2.04	.35	1/2	1 1/16	1 1/4	1 1/4	2 1/2	.5
14	BS1414-2	1.00	1.17	.35	1/2	3 1/32	1 1/4	1 3/16	3/8	.1

Paso 16

24	BS1624-2	1.50	1.54	.19	1/2	5/8	1	1	7/16	.15
12	BS1612-2	.75	.91	.19	3/8	3 3/64	1 1/4	2 1/2	1 1/2	.08
24	BS1624-15	1.50	1.55	.25	1/2	3/4	1 1/16	1 1/4	3/16	.40
16	BS1616-15	1.00	1.13	.25	3/8	4 1/64	1 1/4	1 3/16	7/16	.09
32	BS1632-2	2.00	2.04	.35	1/2	9/64	1 1/16	1 1/4	1/2	.30
16	BS1616-2	1.00	1.15	.35	3/8	2 1/32	1 1/2	1 3/16	7/16	.04
48	BS1648-3	3.00	3.02	.42	5/8	7/8	1 1/16	1 1/2	3/16	.74
16	B1616-3	1.00	1.17	.42	7/16	5 3/64	2	7/8	1 3/32	.13
64	BS1664-4	4.00	4.02	.48	5/8	5 3/64	1 1/4	2 1/4	3/16	1.7
16	B1616-4	1.00	1.17	.48	1/2	5 3/64	2 1/2	1 3/16	1 3/32	.12

Los engranes cónicos de acero pueden ser suministrados con dientes endurecidos con un leve costo adicional.

Hierro Fundido

Número de Parte	Revoluciones por Minuto							
	50	100	200	300	600	900	1200	1800
B330-2	2.5	4.5	7.7	10.0	15.3			
B315-2	2.5	4.5	7.7	10.0	15.3			
B432-2	1.33	2.3	4.0	5.3	8.0	9.5		
B416-2	1.33	2.3	4.0	5.3	8.0	9.5		
B442-3	1.10	2.0	3.7	5.0	7.5	9.0		
B414-3	1.10	2.0	3.7	5.0	7.5	9.0		
B456-4	1.4	2.5	4.4	6.0	9.0	10.9		
B414-4	1.4	2.5	4.4	6.0	9.0	10.9		
B530-2	.5	1.0	1.9	2.5	3.9	4.8	5.5	
B515-2	.5	1.0	1.9	2.5	3.9	4.8	5.5	
B545-3	.7	1.4	2.4	3.3	5.2	6.4	7.2	
B515-3	.7	1.4	2.4	3.3	5.2	6.4	7.2	
B560-4	1.0	1.8	3.3	4.4	6.9	8.4	9.5	
B515-4	1.0	1.8	3.3	4.4	6.9	8.4	9.5	
B636-2	.5	1.0	1.7	2.3	3.7	4.4	5.0	
B618-2	.5	1.0	1.7	2.3	3.7	4.4	5.0	
B642-2	.6	1.1	2.0	2.7	4.0	5.0		
B621-2	.6	1.1	2.0	2.7	4.0	5.0		
B645-3	.4	.8	1.4	2.0	3.2	3.9	4.6	
B615-3	.4	.8	1.4	2.0	3.2	3.9	4.6	
B648-2	.8	1.5	2.5	3.4	5.1	6.1		
B624-2	.8	1.5	2.5	3.4	5.1	6.1		
B660-4	.5	.9	1.7	2.3	3.7	4.6	5.2	
B615-4	.5	.9	1.7	2.3	3.7	4.6	5.2	
B840-2	.4	.7	1.3	1.8	2.9	3.7	4.2	
B820-2	.4	.7	1.3	1.8	2.9	3.7	4.2	
B848-3	.2	.4	.7	1.0	1.7	2.2	2.5	2.9
B816-3	.2	.4	.7	1.0	1.7	2.2	2.5	2.9
B864-4	.2	.4	.7	1.0	1.7	2.2	2.5	
B816-4	.2	.4	.7	1.0	1.7	2.2	2.5	
B872-4	.4	.7	1.2	1.8	2.8	3.6	4.2	
B818-4	.4	.7	1.2	1.8	2.8	3.6	4.2	
B1060-3	.17	.3	.6	.8	1.3	1.7	1.9	2.3
B1020-3	.17	.3	.6	.8	1.3	1.7	1.9	2.3
B1060-4	.1	.2	.4	.5	.9	1.2	1.4	1.8
B1015-4	.1	.2	.4	.5	.9	1.2	1.4	1.8
B1090-6	.14	.25	.5	.7	1.2	1.7	1.9	2.3
B1015-6	.14	.25	.5	.7	1.2	1.7	1.9	2.3
B1236-2	.05	.11	.2	.3	.5	.6	.8	1.0
B1218-2	.05	.11	.2	.3	.5	.6	.8	1.0
B1254-3	.07	.15	.3	.4	.7	.9	1.0	1.3
B1218-3	.07	.15	.3	.4	.7	.9	1.0	1.3
B1272-4	.07	.15	.3	.4	.7	.9	1.1	1.4
B1218-4	.07	.15	.3	.4	.7	.9	1.1	1.4
B1272-6	.06	.11	.2	.3	.6	.8	1.0	1.2
B1212-6	.06	.11	.2	.3	.6	.8	1.0	1.2

Acero

Número de Parte	Revoluciones por Minuto							
	50	100	200	300	600	900	1200	1800
BS636-2	.9	1.7	3.0	4.1	6.4	8.0	9.0	
BS618-2	.9	1.7	3.0	4.1	6.4	8.0	9.0	
BS840-2	.5	.9	1.5	2.1	3.5	4.4	5.0	
BS820-2	.5	.9	1.5	2.1	3.5	4.4	5.0	
BS1030-15	.2	.4	.7	1.0	1.7	2.1	2.3	2.9
BS1020-15	.2	.4	.7	1.0	1.7	2.1	2.3	2.9
BS1040-2	.25	.5	.9	1.3	2.1	2.7	3.0	3.7
BS1020-2	.25	.5	.9	1.3	2.1	2.7	3.0	3.7
BS1050-2	.33	.64	1.2	1.6	2.5	3.2	3.7	
B1025-2	.33	.64	1.2	1.6	2.5	3.2	3.7	
BS1060-3	.3	.5	1.0	1.4	2.4	3.0	3.5	4.3
BS1020-3	.3	.5	1.0	1.4	2.4	3.0	3.5	4.3
BS1227-15	.09	.17	.33	.5	.8	1.0	1.2	1.6
BS1218-15	.09	.17	.33	.5	.8	1.0	1.2	1.6
BS1236-2	.12	.25	.4	.6	1.0	1.4	1.7	2.0
BS1218-2	.12	.25	.4	.6	1.0	1.4	1.7	2.0
BS1236-2A	.12	.25	.4	.6	1.0	1.4	1.7	2.0
BS1218-2A	.12	.25	.4	.6	1.0	1.4	1.7	2.0
BS1248-2	.18	.37	.7	.9	1.6	2.0	2.3	2.8
B1224-2	.18	.37	.7	.9	1.6	2.0	2.3	2.8
BS1254-3	.14	.28	.5	.7	1.2	1.6	1.9	2.3
B1218-3	.14	.28	.5	.7	1.2	1.6	1.9	2.3
BS1428-2	.05	.08	.16	.20	.40	.54	.7	.8
BS1414-2	.05	.08	.16	.20	.40	.54	.7	.8
BS1624-2	.02	.03	.05	.08	.14	.20	.25	.3
BS1612-2	.02	.03	.05	.08	.14	.20	.25	.3
BS1624-15	.03	.05	.09	.14	.25	.33	.4	.5
BS1612-15	.03	.05	.09	.14	.25	.33	.4	.5
BS1632-2	.03	.08	.14	.20	.37	.5	.6	.8
BS1616-2	.03	.08	.14	.20	.37	.5	.6	.8
BS1648-3	.05	.09	.17	.25	.50	.6	.8	1.0
BS1616-3	.05	.09	.17	.25	.50	.6	.8	1.0
BS1664-4	.05	.10	.20	.33	.50	.7	.9	1.1
BS1616-4	.05	.10	.20	.33	.50	.7	.9	1.1

Engranés Cónicos

Relación 1:1

Ángulo de Presión 20°

Martin



Los engranes cónicos se utilizan como transmisiones en ángulo recto, transmiten potencia entre la intersección de los ejes con una relación de velocidad de 1:1. Se utilizan en aplicaciones que requieran una gran eficiencia. Este tipo de engrane sólo puede operar con otro engrane que tenga el mismo número de dientes, el mismo paso y el mismo ángulo de presión. Se pueden utilizar más de dos engranes cónicos de este tipo como en un diferencial.

El empuje en este tipo de engranes hace que estos se separen. Por lo anterior se deben utilizar rodamientos de bolas o de rodillos en lugar de rodamientos encamisados. También se debe considerar el uso de rodamientos de empuje para absorber el empuje producido por esta transmisión.

Todos los engranes cónicos rectos rel. 1:1 de *Martin* se deberán montar en ángulo recto (90 grados) para obtener el soporte adecuado de los dientes.

Todos los engranes cónicos rectos rel. 1:1 y cónicos rectos de *Martin* son generados con la forma de diente Coniflex. Esto permite un ligero desalineamiento de los engranes debido a que el soporte del diente corre a lo largo del diente.

La distancia de montaje debe mantenerse para permitir un juego adecuado entre los engranes. Con esto también se asegurará que los extremos de los dientes del engrane embonen unos con

otros. Para este tipo de engranes se recomienda utilizar como lubricante aceite mineral.

Los engranes cónicos rel. 1:1 de *Martin* en existencia se fabrican con acero al carbón 0.40.

La serie "M" se suministra sin endurecer y en barreno piloto

La serie "HM" se suministra con dientes endurecidos y en barreno piloto

La serie "HMK" se suministra con dientes endurecidos, con cuñero y opresor para instalarse en el eje.

Los engranes con dientes endurecidos tienen una mayor resistencia al desgaste y una capacidad de transmisión de potencia aproximadamente 50% mayor que los engranes sin endurecer.

Los engranes cónicos rel. 1:1 de *Martin* se cortan con el sistema de ángulo de presión de 20°, por lo que no operarán con ningún otro sistema de ángulo de presión.

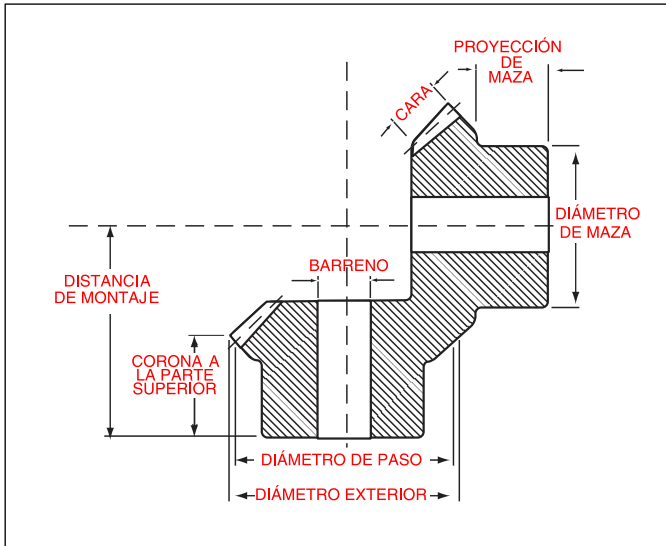

Acero – Barreno Piloto – Dientes no Endurecidos

No. de Dientes	Número de Parte	Diámetro		Cara (Pulg.)	Barreno (Pulg.)		Montaje (Pulg.)	Maza (Pulg.)		Peso Aprox. (lb)
		Paso	Exterior		Diámetro	Largo		Diámetro	Proy. (lb)	

Paso 4

24	M424	6.00	6.36	1.33	1½	3 ³ / ₁₆	5½	4	1 ¹⁵ / ₁₆	14.4
24	M424A	6.00	6.36	1.33	1½	3 ³ / ₁₆	5½	4	1 ¹⁵ / ₁₆	13.7
28	M428	7.00	7.36	1.43	2	3 ³ / ₁₆	6	5	1 ¹⁵ / ₁₆	21.1

Paso 5

25	M525	5.00	5.29	1.10	1½	3	4 ⁵ / ₁₆	3½	1¾	8.5
25	M525A	5.00	5.29	1.10	1½	3	4 ⁵ / ₁₆	3½	1¾	8.3
25	M525B	5.00	5.29	1.10	1¾	3	4 ⁵ / ₁₆	3½	1¾	7.8

Paso 6

24	M624	4.00	4.24	.86	1¼	2 ⁵ / ₁₆	3 ³ / ₁₆	3	1 ¹ / ₁₆	4.4
24	M624A	4.00	4.24	.86	1½	2 ⁵ / ₁₆	3 ³ / ₁₆	3	1 ¹ / ₁₆	4.3
27	M627	4.50	4.74	.96	1¼	2 ⁵ / ₁₆	4 ¹ / ₁₆	3¼	1½	6.3
27	M627A	4.50	4.74	.96	1½	2 ⁵ / ₁₆	4 ¹ / ₁₆	3¼	1½	5.9

Paso 8

24	M824	3.00	3.18	.64	¾	1 ³⁷ / ₆₄	2 ¹ / ₁₆	1¾	1 ¹³ / ₁₆	1.5
24	M824A	3.00	3.18	.64	1	1 ⁴⁹ / ₆₄	2 ¹ / ₁₆	2½	1	2.1
24	M824B	3.00	3.18	.64	1¼	1 ⁴⁹ / ₆₄	2 ¹ / ₁₆	2½	1	1.9
28	M828	3.50	3.68	.75	1	2 ³ / ₃₂	3 ¹ / ₁₆	2½	1¼	2.9
28	M828A	3.50	3.68	.75	1 ¹ / ₁₆	2 ³ / ₃₂	3 ¹ / ₁₆	2½	1¼	2.8
28	M828B	3.50	3.68	.75	1¼	2 ³ / ₃₂	3 ¹ / ₁₆	2½	1¼	2.6
32	M832	4.00	4.18	.84	1	2 ³ / ₃₂	3 ¹ / ₁₆	3	1½	4.8

Paso 10

20	M1020A	2.00	2.14	.44	½	1 ²⁹ / ₆₄	2	1½	1 ¹³ / ₁₆	.75
20	M1020B	2.00	2.14	.44	¾	1 ²⁹ / ₆₄	2	1½	1 ¹³ / ₁₆	.72
20	M1020	2.00	2.14	.44	¾	1 ²⁹ / ₆₄	2	1½	1 ¹³ / ₁₆	.67
20	M1020C	2.00	2.14	.44	7 ¹ / ₈	1 ²⁹ / ₆₄	2	1½	1 ¹³ / ₁₆	.58
25	M1025	2.50	2.64	.55	¾	1 ¹ / ₁₆	2 ¹ / ₁₆	2	1 ¹⁵ / ₁₆	1.2
25	M1025A	2.50	2.64	.55	7 ¹ / ₈	1 ¹ / ₁₆	2 ¹ / ₁₆	2	1 ¹⁵ / ₁₆	1.2
25	M1025B	2.50	2.64	.55	1	1 ¹ / ₁₆	2 ¹ / ₁₆	2	1 ¹⁵ / ₁₆	1.2
30	M1030	3.00	3.14	.64	¾	1 ¹ / ₁₆	2 ¹ / ₁₆	2	1	1.8

Engranés Cónicos

Relación 1:1

Ángulo de Presión 20°

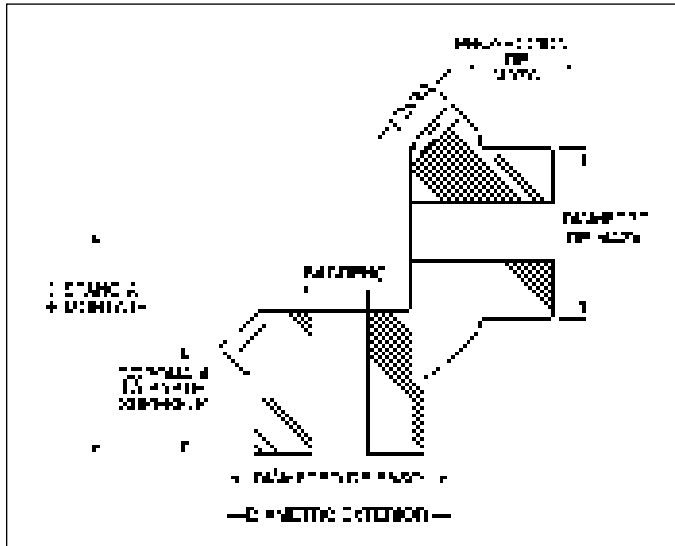

Acero – Barreno Piloto – Dientes no Endurecidos

No. de Dientes	Número de Parte	Diámetro		Cara (Pulg.)	Barreno (Pulg.)		Montaje (Pulg.)	Maza (Pulg.)		Peso Aprox. (lb)
		Paso	Exterior		Diámetro	Largo		Diámetro	Proy. (lb)	

Paso 12

15	M1215	1.25	1.37	.27	$\frac{3}{8}$	$\frac{5}{16}$	1 $\frac{1}{4}$	1	$\frac{1}{2}$.17
15	M1215A	1.25	1.37	.27	$\frac{3}{8}$	$\frac{5}{16}$	1 $\frac{1}{4}$	1	$\frac{1}{2}$.16
15	M1215B	1.25	1.37	.27	$\frac{1}{2}$	$\frac{5}{16}$	1 $\frac{1}{4}$	1	$\frac{1}{2}$.15
18	M1218	1.50	1.62	.32	$\frac{1}{2}$	1 $\frac{1}{4}$	1 $\frac{1}{2}$	1 $\frac{1}{4}$	$\frac{3}{8}$.30
18	M1218A	1.50	1.62	.32	$\frac{3}{4}$	1 $\frac{1}{4}$	1 $\frac{1}{2}$	1 $\frac{1}{4}$	$\frac{3}{8}$.25
18	M1218B	1.50	1.62	.32	$\frac{3}{4}$	1 $\frac{1}{4}$	1 $\frac{1}{2}$	1 $\frac{1}{4}$	$\frac{3}{8}$.22
21	M1221	1.75	1.87	.39	$\frac{1}{2}$	1 $\frac{1}{8}$	1 $\frac{1}{4}$	1 $\frac{1}{8}$	$\frac{1}{16}$.45
21	M1221A	1.75	1.87	.39	$\frac{5}{16}$	1 $\frac{1}{8}$	1 $\frac{1}{4}$	1 $\frac{1}{8}$	$\frac{1}{16}$.45
21	M1221B	1.75	1.87	.39	$\frac{3}{4}$	1 $\frac{1}{8}$	1 $\frac{1}{4}$	1 $\frac{1}{8}$	$\frac{1}{16}$.43
21	M1221C	1.75	1.87	.39	$\frac{3}{4}$	1 $\frac{1}{8}$	1 $\frac{1}{4}$	1 $\frac{1}{8}$	$\frac{1}{16}$.38
24	M1224	2.00	2.12	.43	$\frac{1}{2}$	1 $\frac{3}{16}$	1 $\frac{1}{2}$	1 $\frac{1}{2}$	$\frac{1}{16}$.62
30	M1230	2.50	2.62	.54	$\frac{3}{8}$	1 $\frac{3}{16}$	2 $\frac{1}{16}$	1 $\frac{1}{4}$	$\frac{27}{32}$	1.10

Paso 14

14	M1414	1.00	1.11	.19	$\frac{3}{8}$	$\frac{7}{16}$	1 $\frac{1}{8}$	$\frac{7}{8}$	$\frac{1}{2}$.10
14	M1414A	1.00	1.11	.19	$\frac{3}{8}$	$\frac{7}{16}$	1 $\frac{1}{8}$	$\frac{7}{8}$	$\frac{1}{2}$.09

Paso 16

12	M1612	.75	.84	.16	$\frac{3}{16}$	$\frac{3}{8}$	$\frac{1}{8}$	$\frac{3}{4}$	$\frac{3}{4}$.05
16	M1616	1.00	1.09	.22	$\frac{3}{8}$	$\frac{3}{4}$	1 $\frac{1}{8}$	$\frac{3}{4}$	$\frac{3}{8}$.07
20	M1620	1.25	1.34	.27	$\frac{7}{16}$	$\frac{21}{32}$	1 $\frac{1}{4}$	1	$\frac{1}{2}$.16
24	M1624	1.50	1.59	.31	$\frac{1}{2}$	$\frac{7}{8}$	1 $\frac{1}{2}$	1	$\frac{1}{2}$.20

Paso 20

20	M2020	1.00	1.07	.23	$\frac{3}{8}$	$\frac{13}{16}$	1 $\frac{1}{2}$	$\frac{3}{4}$	$\frac{1}{2}$.06
25	M2025	1.25	1.32	.25	$\frac{3}{8}$	$\frac{3}{4}$	1 $\frac{1}{8}$	1	$\frac{3}{8}$.14

Paso 24

24	M2424	1.00	1.06	.20	$\frac{1}{4}$	$\frac{9}{16}$	$\frac{27}{32}$	$\frac{3}{4}$	$\frac{3}{8}$.12
----	-------	------	------	-----	---------------	----------------	-----------------	---------------	---------------	-----

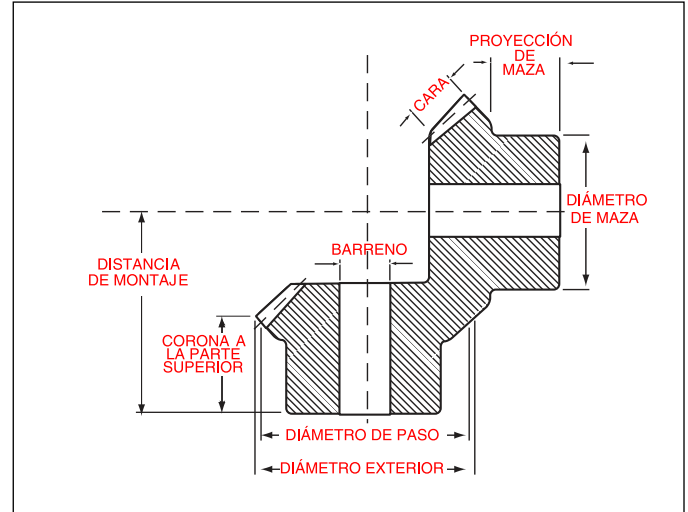

Acero – Barreno Piloto – Dientes Endurecidos

No. de Dientes	Número de Parte	Diámetro		Cara (Pulg.)	Barreno (Pulg.)		Montaje (Pulg.)	Maza (Pulg.)		Peso Aprox. (lb)
		Paso	Exterior		Diámetro	Largo		Diámetro	Proy. (lb)	

Paso 4

24	HM424	6.00	6.36	1.33	1½	3⅞	5½	4	1⅝	14.4
24	HM424A	6.00	6.36	1.33	1½	3⅞	5½	4	1⅝	13.7
28	HM428	7.00	7.36	1.43	2	3⅞	6	5	1⅝	21.1

Paso 5

25	HM525	5.00	5.29	1.10	1½	3	4⅞	3½	1¾	8.5
25	HM525A	5.00	5.29	1.10	1½	3	4⅞	3½	1¾	8.3
25	HM525B	5.00	5.29	1.10	1½	3	4⅞	3½	1¾	7.5

Paso 6

24	HM624	4.00	4.24	.86	1¼	2⅞	3⅞	3	1⅝	4.4
24	HM624A	4.00	4.24	.86	1¼	2⅞	3⅞	3	1⅝	4.0
27	HM627	4.50	4.74	.96	1¼	2⅞	4⅞	3¼	1½	6.3
27	HM627A	4.50	4.74	.96	1¼	2⅞	4⅞	3¼	1½	5.9

Paso 8

24	HM824	3.00	3.18	.64	¾	1⅝	2⅞	1¾	1⅝	1.5
24	HM824A	3.00	3.18	.64	1	1⅝	2⅞	2½	1	2.1
24	HM824B	3.00	3.18	.64	1¼	1⅝	2⅞	2½	1	2.6
28	HM828	3.50	3.68	.75	1	2⅞	3¼	2½	1¼	3.0
28	HM828A	3.50	3.68	.75	1⅝	2⅞	3¼	2½	1¼	2.8
28	HM828B	3.50	3.68	.75	1¼	2⅞	3¼	2½	1¼	2.6
32	HM832	4.00	4.18	.85	1	2⅞	3⅞	3	1⅝	4.7

Paso 10

20	HM1020A	2.00	2.14	.44	½	1⅝	2	1½	1⅝	.76
20	HM1020B	2.00	2.14	.44	¾	1⅝	2	1½	1⅝	.70
20	HM1020	2.00	2.14	.44	¾	1⅝	2	1½	1⅝	.64
20	HM1020C	2.00	2.14	.44	¾	1⅝	2	1½	1⅝	.58
25	HM1025	2.50	2.64	.55	¾	1⅝	2⅞	2	1⅝	1.3
25	HM1025A	2.50	2.64	.55	1	1⅝	2⅞	2	1⅝	1.2
25	HM1025B	2.50	2.64	.55	¾	1⅝	2⅞	2	1⅝	1.2
30	HM1030	3.00	3.14	.64	¾	1¾	2⅞	2	1	1.8

Engranés Cónicos

Relación 1:1

Ángulo de Presión 20°

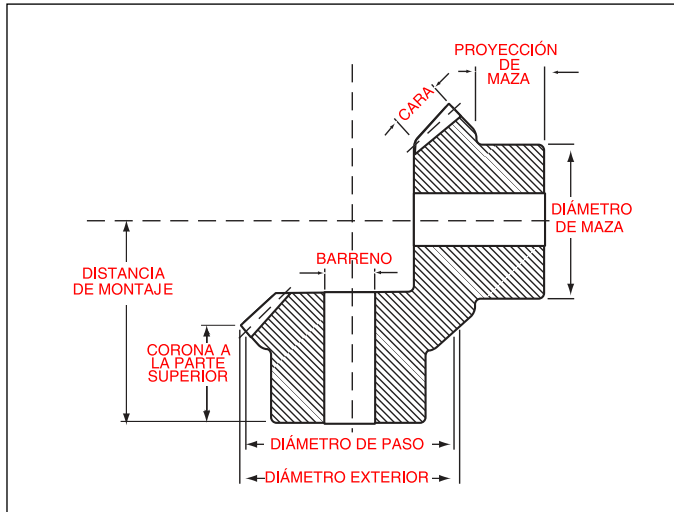

Acero – Barreno Piloto – Dientes Endurecidos

No. de Dientes	Número de Parte	Diámetro		Cara (Pulg.)	Barreno (Pulg.)		Montaje (Pulg.)	Maza (Pulg.)		Peso Aprox. (lb)
		Paso	Exterior		Diámetro	Largo		Diámetro	Proy. (lb)	

Paso 12

15	HM1215	1.25	1.37	.27	$\frac{3}{8}$	$\frac{5}{64}$	$\frac{1}{4}$	1	$\frac{1}{2}$.15
15	HM1215A	1.25	1.37	.27	$\frac{7}{16}$	$\frac{5}{64}$	$\frac{1}{4}$	1	$\frac{1}{2}$.15
15	HM1215B	1.25	1.37	.27	$\frac{1}{2}$	$\frac{5}{64}$	$\frac{1}{4}$	1	$\frac{1}{2}$.15
18	HM1218	1.50	1.62	.32	$\frac{1}{2}$	$1\frac{1}{64}$	$\frac{1}{2}$	$\frac{1}{4}$	$\frac{5}{8}$.30
18	HM1218A	1.50	1.62	.32	$\frac{5}{8}$	$1\frac{1}{64}$	$\frac{1}{2}$	$\frac{1}{4}$	$\frac{5}{8}$.25
18	HM1218B	1.50	1.62	.32	$\frac{3}{4}$	$1\frac{1}{64}$	$\frac{1}{2}$	$\frac{1}{4}$	$\frac{5}{8}$.22
21	HM1221	1.75	1.87	.39	$\frac{1}{2}$	$1\frac{3}{16}$	$\frac{1}{4}$	$\frac{1}{4}$	$\frac{1}{16}$.22
21	HM1221B	1.75	1.87	.39	$\frac{5}{8}$	$1\frac{3}{16}$	$\frac{1}{4}$	$\frac{1}{4}$	$\frac{1}{16}$.42
24	HM1224	2.00	2.12	.43	$\frac{1}{2}$	$1\frac{7}{32}$	$\frac{1}{2}$	$\frac{1}{2}$	$\frac{1}{16}$.62
30	HM1230	2.50	2.62	.54	$\frac{5}{8}$	$1\frac{3}{64}$	$2\frac{5}{16}$	$\frac{1}{4}$	$2\frac{7}{32}$	1.1

Paso 14

14	HM1414	1.00	1.11	.19	$\frac{3}{8}$	$\frac{4}{64}$	$1\frac{1}{16}$	$\frac{7}{8}$	$\frac{1}{2}$.10
14	HM1414A	1.00	1.11	.19	$\frac{7}{16}$	$\frac{4}{64}$	$1\frac{1}{16}$	$\frac{7}{8}$	$\frac{1}{2}$.10

Paso 16

16	HM1616	1.00	1.09	.22	$\frac{3}{8}$	$\frac{3}{4}$	$1\frac{1}{16}$	$\frac{3}{4}$	$\frac{7}{16}$.07
24	HM1624	1.50	1.59	.31	$\frac{1}{2}$	$\frac{7}{8}$	1	1	$\frac{1}{2}$.20

Paso 24

24	HM2424	1.00	1.06	.20	$\frac{1}{4}$	$\frac{9}{16}$	$2\frac{9}{32}$	$\frac{5}{8}$	$\frac{9}{32}$.06
----	--------	------	------	-----	---------------	----------------	-----------------	---------------	----------------	-----

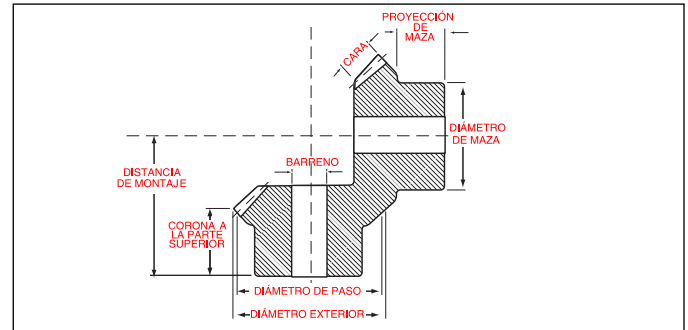

Acero – Suministrados con Cuñero y Opressor – Dientes Endurecidos

No. de Dientes	Número de Parte	Diámetro		Cara (Pulg.)	Barreno (Pulg.)		Montaje (Pulg.)	Maza (Pulg.)		Peso Aprox. (lb)
		Paso	Exterior		Diámetro	Largo		Diámetro	Proy. (lb)	

Paso 4

24	HMK424A	6.00	6.36	1.33	1 $\frac{1}{4}$	3 $\frac{3}{16}$	5 $\frac{1}{2}$	4	1 $\frac{1}{16}$	13.7
28	HMK428	7.00	7.36	1.43	2	3 $\frac{3}{8}$	6	5	1 $\frac{1}{8}$	20.4

Paso 5

25	HMK525	5.00	5.29	1.10	1 $\frac{1}{2}$	3	4 $\frac{3}{8}$	3 $\frac{1}{2}$	1 $\frac{3}{4}$	8.5
25	HMK525B	5.00	5.29	1.10	1 $\frac{1}{2}$	3	4 $\frac{3}{8}$	3 $\frac{1}{2}$	1 $\frac{3}{4}$	7.5

Paso 6

24	HMK624	4.00	4.24	.86	1 $\frac{1}{4}$	2 $\frac{1}{16}$	3 $\frac{3}{8}$	3	1 $\frac{1}{16}$	4.4
24	HMK624A	4.00	4.24	.86	1 $\frac{1}{2}$	2 $\frac{1}{16}$	3 $\frac{3}{8}$	3	1 $\frac{1}{16}$	4.0
27	HMK627	4.50	4.74	.96	1 $\frac{1}{4}$	2 $\frac{1}{8}$	4 $\frac{1}{8}$	3 $\frac{3}{4}$	1 $\frac{1}{2}$	6.3
27	HMK627A	4.50	4.74	.96	1 $\frac{1}{2}$	2 $\frac{1}{8}$	4 $\frac{1}{8}$	3 $\frac{3}{4}$	1 $\frac{1}{2}$	5.9

Paso 8

24	HMK824	3.00	3.18	.64	$\frac{3}{4}$	1 $\frac{3}{16}$	2 $\frac{1}{16}$	1 $\frac{3}{4}$	1 $\frac{3}{16}$	1.5
24	HMK824A	3.00	3.18	.64	1	1 $\frac{9}{16}$	2 $\frac{1}{8}$	2 $\frac{1}{2}$	1	2.1
24	HMK824B	3.00	3.18	.64	1 $\frac{1}{4}$	1 $\frac{9}{16}$	2 $\frac{1}{8}$	2 $\frac{1}{2}$	1	1.8
28	HMK828	3.50	3.68	.75	1	2 $\frac{3}{32}$	3 $\frac{1}{4}$	2 $\frac{1}{2}$	1 $\frac{1}{4}$	2.9
28	HMK828A	3.50	3.68	.75	1 $\frac{1}{16}$	2 $\frac{3}{32}$	3 $\frac{1}{4}$	2 $\frac{1}{2}$	1 $\frac{1}{4}$	2.7
28	HMK828B	3.50	3.68	.75	1 $\frac{1}{4}$	2 $\frac{3}{32}$	3 $\frac{1}{4}$	2 $\frac{1}{2}$	1 $\frac{1}{4}$	2.6

Paso 10

20	HMK1020A	2.00	2.14	.44	$\frac{1}{2}$	1 $\frac{1}{16}$	2	1 $\frac{1}{8}$	1 $\frac{3}{16}$.74
20	HMK1020B	2.00	2.14	.44	$\frac{3}{4}$	1 $\frac{1}{8}$	2	1 $\frac{1}{8}$	1 $\frac{3}{16}$.70
20	HMK1020	2.00	2.14	.44	$\frac{3}{4}$	1 $\frac{3}{16}$	2	1 $\frac{1}{8}$	1 $\frac{3}{16}$.63
20	HMK1020C	2.00	2.14	.44	$\frac{7}{8}$	1 $\frac{1}{8}$	2	1 $\frac{1}{8}$	1 $\frac{3}{16}$.58
25	HMK1025	2.50	2.64	.55	$\frac{3}{4}$	1 $\frac{1}{8}$	2 $\frac{1}{16}$	2	1 $\frac{5}{16}$	1.30
25	HMK1025A	2.50	2.64	.55	$\frac{7}{8}$	1 $\frac{1}{8}$	2 $\frac{1}{16}$	2	1 $\frac{5}{16}$	1.20
25	HMK1025B	2.50	2.64	.55	1	1 $\frac{1}{8}$	2 $\frac{1}{16}$	2	1 $\frac{5}{16}$	1.10

Paso 12

15	HMK1215B	1.25	1.37	.27	$\frac{1}{2}$	$\frac{5}{16}$	1 $\frac{1}{4}$	1	$\frac{1}{2}$.14
18	HMK1218A	1.50	1.62	.32	$\frac{5}{8}$	1 $\frac{1}{8}$	1 $\frac{1}{2}$	1 $\frac{1}{4}$	$\frac{5}{8}$.25
21	HMK1221B	1.75	1.87	.39	$\frac{3}{4}$	1 $\frac{1}{8}$	1 $\frac{3}{4}$	1 $\frac{1}{2}$	1 $\frac{1}{8}$.41
30	HMK1230	2.50	2.62	.54	$\frac{3}{4}$	1 $\frac{3}{16}$	2 $\frac{1}{16}$	1 $\frac{3}{4}$	2 $\frac{1}{32}$	1.1

Paso 16

16	HMK1616	1.00	1.09	.22	$\frac{5}{8}$	$\frac{3}{8}$	1 $\frac{1}{16}$	$\frac{3}{4}$	$\frac{3}{16}$.07
24	HMK1624	1.50	1.59	.31	$\frac{1}{2}$	$\frac{7}{8}$	1 $\frac{1}{8}$	1	$\frac{1}{2}$.20

Capacidad de Potencia HP de Engranajes Cónicos Relación 1:1

Ángulo de Presión 20°



Acero

Número de Parte	Revoluciones Por Minuto									
	10	25	50	100	200	300	600	900	1200	1800
M424	.80	1.90	3.6	6.4	10.6	13.5	18.8	21.5	23.0	
HM424	1.40	3.33	6.3	11.2	18.6	23.6	33.0	38.0	40.0	
M428	1.07	2.50	4.8	8.4	13.6	17.2	23.3	26.5	28.5	
HM428	1.90	4.50	8.4	14.7	23.8	30.0	40.0	46.0	50.0	
M525	.45	1.05	2.0	3.7	6.3	8.1	11.6	13.6	15.0	
HM525	.75	1.90	3.6	6.5	11.0	14.2	20.0	24.0	26.0	
M624	.25	.55	1.1	2.0	3.5	4.6	6.9	8.2	19.0	10.2
HM624	.40	1.00	1.9	3.5	6.1	8.0	12.0	14.5	16.0	18.0
M627	.30	.75	1.4	2.5	4.3	5.7	8.5	9.9	11.0	12.0
HM627	.50	1.33	2.5	4.4	7.5	10.0	1.5	17.5	19.0	21.0
M824	.10	.25	.5	.9	1.5	2.1	3.3	4.0	4.5	5.3
HM824	.20	.40	.8	1.5	2.6	3.7	5.8	7.0	8.0	9.3
M828	.15	.33	.7	1.2	2.2	2.9	4.4	5.3	6.0	6.8
HM828	.25	.60	1.2	2.1	3.9	5.0	7.7	9.3	10.5	12.0
M832	.20	.45	.9	1.6	2.8	3.7	5.5	6.5	7.2	8.0
HM832	.33	.80	1.5	2.8	4.9	6.5	9.6	11.4	12.5	14.2
M1020	.03	.08	.2	.3	.6	.8	1.3	1.7	2.0	2.4
HM1020	.05	.15	.3	.5	1.0	1.4	2.3	3.0	3.5	4.2
M1025	.06	.15	.3	.5	.9	1.3	2.0	2.5	2.9	3.5
HM1025	.10	.25	.5	.9	1.6	2.3	3.5	4.4	5.0	6.0
M1030	.08	.20	.4	.7	1.3	1.8	2.8	3.5	3.9	4.5
HM1030	.15	.33	.7	1.3	2.3	3.2	4.9	6.1	6.8	8.0
M1215	.01	.02	.05	.10	.20	.3	.5	.6	.8	.9
HM1215	.02	.04	.10	.17	.33	.4	.8	1.0	1.3	1.6
M1218	.01	.03	.08	.14	.25	.4	.7	.9	1.0	1.3
HM1218	.02	.05	.15	.25	.47	.7	1.1	1.5	1.8	2.2
M1221	.02	.05	.11	.20	.40	.5	.9	1.2	1.4	1.7
HM1221	.04	.10	.20	.33	.70	1.0	1.6	2.1	2.5	3.0
M1224	.03	.07	.15	.25	.50	.7	1.2	1.5	1.7	2.0
HM1224	.05	.12	.25	.47	.90	1.2	2.1	2.6	3.0	3.5
M1230	.05	.12	.25	.44	.80	1.1	1.8	2.2	2.5	3.0
HM1230	.09	.21	.40	.75	1.40	1.9	3.2	4.0	4.4	5.3
M1414	.01	.02	.05	.09	.16	.2	.3	.4	.4	.5
HM1414	.02	.04	.09	.16	.2	.4	.6	.7	.7	.9
M1616	.01	.02	.05	.09	.16	.2	.3	.4	.4	.5
HM1616	.02	.04	.09	.16	.2	.4	.6	.7	.7	.9
M1620	.02	.04	.08	.14	.2	.4	.5	.6	.6	.8
HM1620	.04	.07	.15	.25	.4	.7	.9	1.0	1.0	1.3
M1624	.03	.06	.12	.20	.3	.5	.7	.8	.8	1.0
HM1624	.05	.10	.21	.40	.5	.9	1.2	1.4	1.4	1.8
M2020	.01	.02	.04	.08	.1	.2	.2	.4	.4	.5
HM2020	.02	.04	.07	.14	.2	.4	.5	.6	.6	.8
M2025	.02	.03	.06	.12	.2	.3	.4	.5	.5	.6
HM2025	.04	.05	.10	.21	.3	.5	.7	.9	.9	1.0

LAS CAPACIDADES DE POTENCIA A LA DERECHA DE LA LINEA OSCURA EXCEDEN LA VELOCIDAD LINEAL RECOMENDADA.



Corona y Sinfín Mano Derecha



Sinfines con Cuerda Sencilla, Doble y Cuádruple.

CAPACIDAD DE AUTO BLOQUEO

Frecuentemente existe una confusión respecto a la capacidad de auto bloqueo de los engranes de corona y sinfín. Bajo ninguna condición debe esperarse que los engranes de corona sinfín de *Martin* soporten cargas cuando estén detenidos. Lo anterior cubre un amplio espectro de variables que afectan la capacidad de auto bloquearse de un determinado juego de engranes en una aplicación específica. En teoría, un sinfín no girará en sentido inverso si el ángulo de fricción es mayor que el ángulo de la cuerda. Sin embargo, el acabado real de la superficie y la lubricación pueden reducir significativamente esto. Es más, la vibración puede provocar movimiento en el punto de contacto con la consecuente reducción del ángulo de fricción.

En términos generales, si el ángulo de la cuerda es menor a 5° existe una gran posibilidad de que los engranes se auto bloqueen. Sin embargo es importante enfatizar que no hay ninguna garantía de que esto suceda por lo que se deberá informar al cliente. Si la seguridad está involucrada se deberá instalar un freno.

Originalmente, los engranes de corona y sinfín se utilizaban para obtener, de una manera compacta, grandes reducciones de velocidad entre los ejes motriz e impulsado, con un incremento proporcional (excepto por las pérdidas por fricción) en el torque del eje impulsado. Los engranes de corona y sinfín aún se utilizan con este propósito y frecuentemente la corona es impulsada por un sinfín de cuerda sencilla con ángulo bajo en la hélice que impide que la transmisión se regrese; por esta razón la corona no puede impulsar el sinfín ya que los engranes se bloquean automáticamente por si solos evitando girar en sentido inverso (Vea la nota al respecto).

Aunque un sinfín de cuerda múltiple que se utilice bajo las mismas condiciones sea mucho más eficiente que uno de cuerda sencilla, eso no significa que los sinfines de cuerda múltiple deban ser utilizados siempre.

Un sinfín de cuerda sencilla debe preferirse cuando lo más importante sea obtener una relación de velocidad elevada y especialmente si el sinfín deba auto bloquearse.

Cuando la potencia sea el principal factor, se deben usar sinfines de cuerda múltiple.

La lubricación es un factor importante en este tipo de transmisiones. Los incrementos en el calor generado resultan en una reducción en la eficiencia. La potencia que debe ser transmitida a una determinada temperatura se incrementa cuando la eficiencia de los engranes aumenta.

Los materiales de construcción para las coronas y sinfines son por regla general; acero para los sinfines y bronce y hierro fundido para las coronas. Cuando se utilicen sinfines de acero con coronas de bronce en aplicaciones de alta velocidad el sinfín debe endurecerse.

**Dirección de Rotación y Empuje
Mano Derecha**

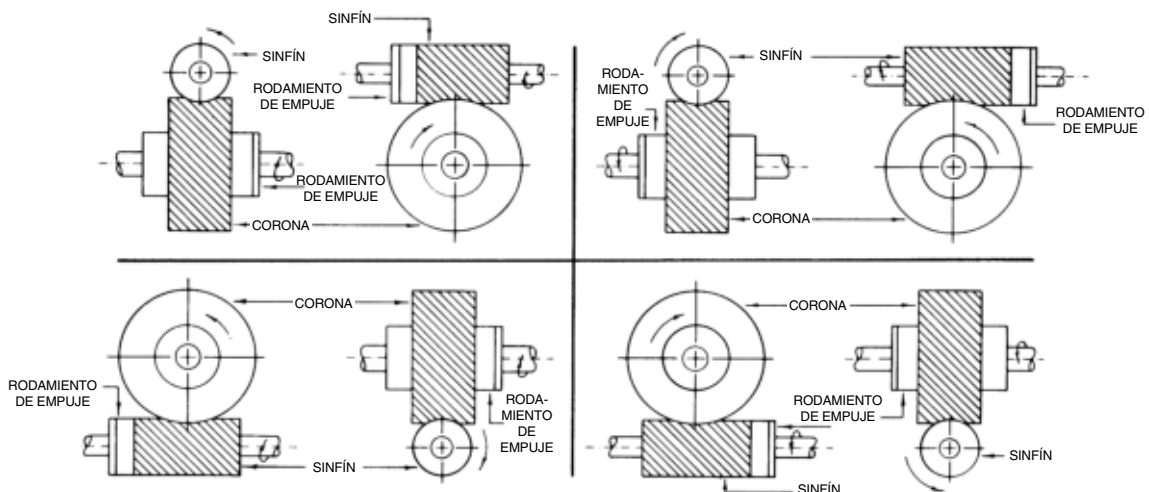

Coronas y Sinfines

Paso 3 • Cara 2" • Ángulo de Presión 14½°

Cuerda Sencilla Mano Derecha (Sólo Mano Derecha en Existencia)

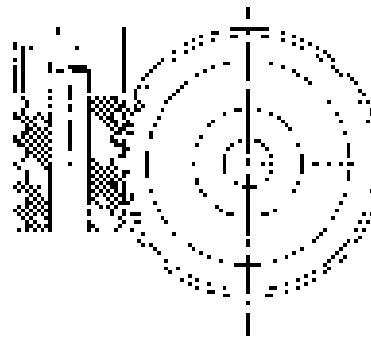
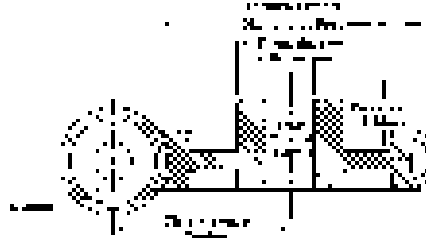

Hierro Fundido

Número de Dientes	Número de Parte Hierro Fundido	Peso Aprox. (lb)	Diám. de Paso	Barreno (Pulg.)	Maza (Pulg.)		Estilo
					Diám.	Proy.	
18	W318	16.2	6.000	1	3	1½	W
24	W324	22.8	8.000	1½	3½	1½	S
30	W330	30.2	10.000	1½	3½	1½	S
36	W336	36.4	12.000	1½	3½	1½	S
54	W354	60.2	18.000	1½	4	1½	S

W = ALMA S = RAYOS



Acero — Sinfines con Ángulo de Hélice de 4° 46'

Número de Parte Suave	Peso Aprox. (lb)	Número de Parte Endurecido	Peso Aprox. (lb)	Cara (Pulg.)	Diám. de Paso	Barreno (Pulg.)	Cuñero (Pulgadas)
W3	12.2	WG3	12.0	4	4.000	1½	¾×¾

Los sinfines con la superficie endurecida tienen las cuerdas pulidas (Se indica con la letra "G" en el número de parte).

Nota: Puede ser difícil modificar los barrenos existentes en los sinfines endurecidos.

Cuerda Sencilla Mano Derecha (Sólo Mano Derecha en Existencia)

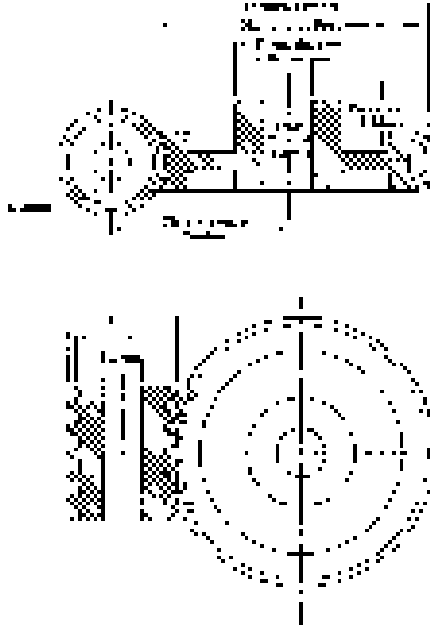

Hierro Fundido

Número de Dientes	Número de Parte Hierro Fundido	Peso Aprox. (lb)	Diám. de Paso	Barreno (Pulg.)	Maza (Pulg.)		Estilo
					Diám.	Proy.	
20	W420	8.4	5.000	1	2½	1¼	W
24	W424	12.9	6.000	1	2½	1¼	W
32	W432	15.6	8.000	1¼	3	1¼	W
40	W440	27.5	10.000	1¼	3	1¼	W
48	W448	34.1	12.000	1½	4	1¼	W
64	W464	43.9	16.000	1½	4	1¼	S

W = ALMA S = RAYOS



Acero — Sinfines con Ángulo de Hélice de 4° 46'

Número de Parte Suave	Peso Aprox. (lb)	Número de Parte Endurecido	Peso Aprox. (lb)	Cara (Pulg.)	Diám. de Paso	Barreno (Pulg.)	Cuñero (Pulgadas)
W4	5.6	WG4	5.5	3¾	3.000	1¼	¾x¾

Los sinfines con la superficie endurecida tienen las cuerdas pulidas (Se indica con la letra "G" en el número de parte).

Nota: Puede ser difícil modificar los barrenos existentes en los sinfines endurecidos.

Coronas y Sinfines

Paso 6 • Cara 1" • Ángulo de Presión 14½°

Cuerda Sencilla Mano Derecha (Sólo Mano Derecha en Existencia)

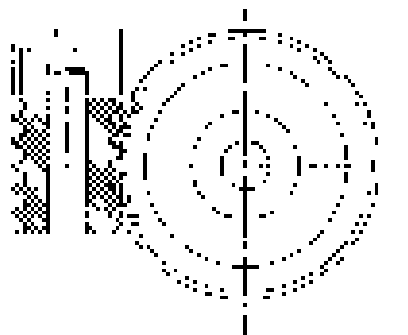
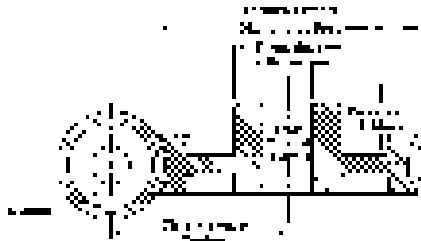

Hierro Fundido

Número de Dientes	Número de Parte Hierro Fundido	Peso Aprox. (lb)	Diám. de Paso	Barreno (Pulg.)	Maza (Pulg.)		Estilo
					Diám.	Proy.	
20	W620	2.5	3.333	¾	1½	¾	W
24	W624	3.6	4.000	¾	1½	¾	W
30	W630	5.0	5.000	¾	2¼	¾	W
36	W636	6.0	6.000	1	2½	¾	W
40	W640	7.6	6.667	1	2½	¾	W
48	W648	9.2	8.000	1¼	2¾	1	W
60	W660	13.7	10.000	1¼	3	1¼	W
72	W672	14.9	12.000	1¼	3	1¼	W

Tiene un diámetro de maza de 2¾" y una proyección de maza de 1¼". W= Alma



Acero — Sinfines con Ángulo de Hélice de 4° 46'

Número de Parte Suave	Peso Aprox. (lb)	Número de Parte Endurecido	Peso Aprox. (lb)	Cara (Pulg.)	Diám. de Paso	Barreno (Pulg.)	Maza (Pulg.)		Cuñero (Pulgadas)
							Diám.	Proy.	
W6	1.8	WG6	1.7	2½	2.000	¾	1⅞	¾	⅜x⅜
WH6	2.7			2½	2.000	¾	1⅞	¾	⅜x⅜

Los sinfines con la superficie endurecida tienen las cuerdas pulidas (Se indica con la letra "G" en el número de parte).

Nota: Puede ser difícil modificar los barrenos existentes en los sinfines endurecidos.

Cuerda Doble Mano Derecha (Sólo Mano Derecha en Existencia)

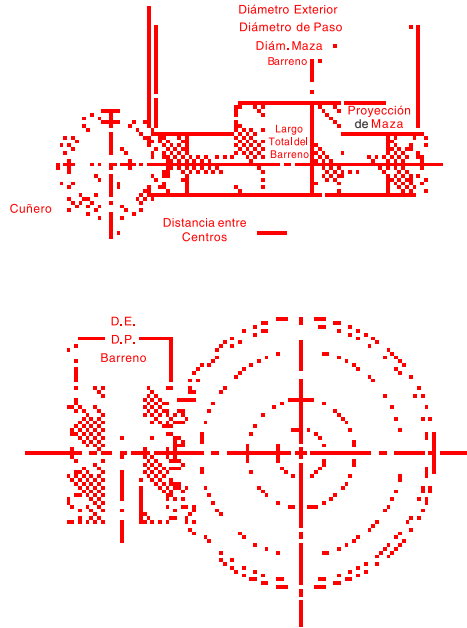

Hierro Fundido

Número de Dientes	Número de Parte Hierro Fundido	Peso Aprox. (lb)	Diám. de Paso	Barreno (Pulg.)	Maza (Pulg.)		Estilo
					Diám.	Proy.	
20	W620D	3.3	3.333	1	2½	1	SIMPLE
24	W624D	4.1	4.000	1½	2½	1	SIMPLE
30	W630D	5.2	5.000	1½	2½	1	W
40	W640D	7.6	6.667	1½	2½	1	W

W = ALMA



Acero — Sinfines con Ángulo de Hélice de 9° 28'

Número de Parte Suave	Peso Aprox. (lb)	Cara (Pulg.)	Diám. de Paso	Barreno (Pulg.)	Cuñero (Pulgadas)
W6D	1.6	2½	2.000	1	¼×¼

Coronas y Sinfines

Paso 6 • Cara 1" • Ángulo de Presión 14½°

Cuerda Cuádruple Mano Derecha (Sólo Mano Derecha en Existencia)

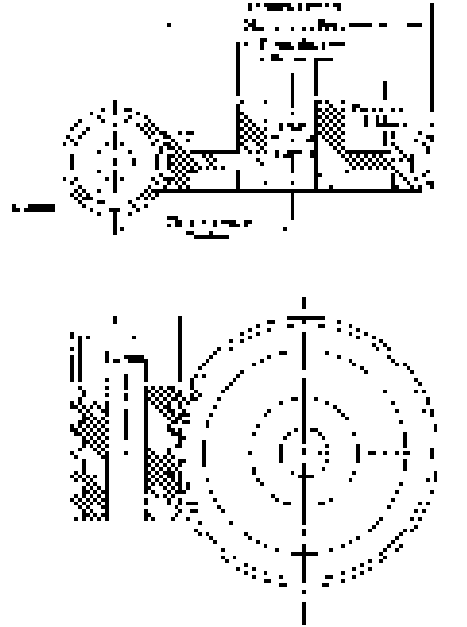

Hierro Fundido

Número de Dientes	Número de Parte Hierro Fundido	Peso Aprox. (lb)	Diám. de Paso	Barreno (Pulg.)	Maza (Pulg.)		Estilo
					Diám.	Proy.	
20	W620Q	3.4	3.333	1	2%	1	SIMPLE
24	W624Q	4.1	4.000	1½	2%	1	SIMPLE

W = ALMA



Acero — Sinfines con Ángulo de Hélice de 18° 26'

Número de Parte Suave	Peso Aprox. (lb)	Cara (Pulg.)	Diám. de Paso	Barreno (Pulg.)	Cuñero (Pulgadas)
W6Q	1.6	2%	2.000	1	¼x¼

Cuerda Sencilla Mano Derecha (Sólo Mano Derecha en Existencia)

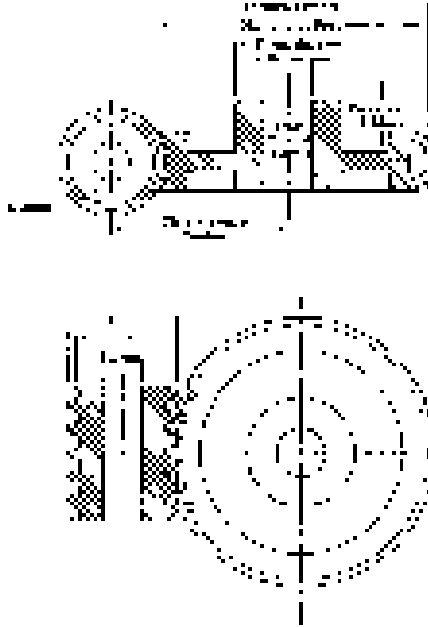

Hierro Fundido

Número de Dientes	Número de Parte Hierro Fundido	Peso Aprox. (lb)	Diám. de Paso	Barreno (Pulg.)	Maza (Pulg.)		Estilo
					Diám.	Proy.	
20	W820	1.3	2.500	$\frac{3}{4}$	$1\frac{1}{4}$	$\frac{3}{4}$	SIMPLE
30	W830	2.4	3.750	$\frac{3}{4}$	$1\frac{1}{4}$	$\frac{3}{4}$	W
40	W840	3.7	5.000	1	$2\frac{1}{2}$	$\frac{7}{8}$	W
48	W848	4.5	6.000	1	$2\frac{1}{2}$	$\frac{7}{8}$	W
50	W850	5.1	6.250	1	$2\frac{1}{2}$	$\frac{7}{8}$	W
60	W860	6.1	7.500	1	$2\frac{1}{2}$	$\frac{7}{8}$	W
80	W880	8.9	10.000	$1\frac{1}{4}$	3	$\frac{7}{8}$	W

W = ALMA



Acero — Sinfines con Ángulo de Hélice de $4^\circ 46'$

Número de Parte Suave	Peso Aprox. (lb)	Número de Parte Endurecido	Peso Aprox. (lb)	Cara (Pulg.)	Diám. de Paso	Barreno (Pulg.)	Maza (Pulg.)		Cuñero (Pulgadas)
							Diám.	Proy.	
W8	.64	WG8	.62	$1\frac{1}{4}$	1.500	$\frac{3}{4}$	$1\frac{1}{6}$	$\frac{5}{8}$	$\frac{3}{16} \times \frac{3}{32}$
WH8	.74			$1\frac{1}{4}$	1.500	$\frac{3}{4}$			

Los sinfines con la superficie endurecida tienen las cuerdas pulidas (Se indica con la letra "G" en el número de parte).

Nota: Puede ser difícil modificar los barrenos existentes en los sinfines endurecidos.

Coronas y Sinfines

Paso 8 • Cara $\frac{3}{4}$ " • Ángulo de Presión $14\frac{1}{2}^\circ$

Cuerda Doble Mano Derecha (Sólo Mano Derecha en Existencia)

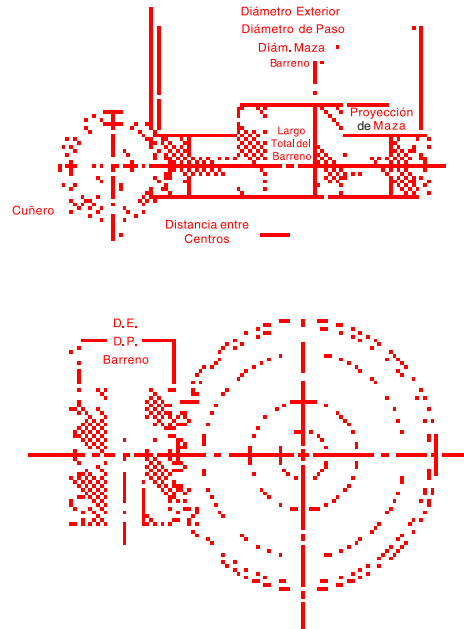

Hierro Fundido

Número de Dientes	Número de Parte Hierro Fundido	Peso Aprox. (lb)	Diám. de Paso	Barreno (Pulg.)	Maza (Pulg.)		Estilo
					Diám.	Proy.	
20	W820D	1.2	2.500	1	2	$\frac{3}{4}$	SIMPLE
30	W830D	2.5	3.750	1	$2\frac{1}{4}$	$\frac{3}{4}$	W
40	W840D	3.4	5.000	1	$2\frac{1}{4}$	$\frac{3}{4}$	W

W = ALMA



Acero — Sinfines con Ángulo de Hélice de $9^\circ 28'$

Número de Parte Suave	Peso Aprox. (lb)	Número de Parte Endurecido	Peso Aprox. (lb)	Cara (Pulg.)	Diám. de Paso	Barreno (Pulg.)	Maza (Pulg.)		Cuñero (Pulgadas)
							Diám.	Proy.	
W8D	.56	WG8D	.54	$1\frac{1}{4}$	1.500	$\frac{7}{8}$	$1\frac{1}{8}$	$\frac{5}{8}$	$\frac{3}{16} \times \frac{3}{32}$
WH8D	.74			$1\frac{1}{4}$	1.500	$\frac{3}{4}$	$\frac{5}{8}$	$\frac{5}{8}$	

Los sinfines con la superficie endurecida tienen las cuerdas pulidas (Se indica con la letra "G" en el número de parte).

Nota: Puede ser difícil modificar los barrenos existentes en los sinfines endurecidos.

Cuerda Cuádruple Mano Derecha (Sólo Mano Derecha en Existencia)

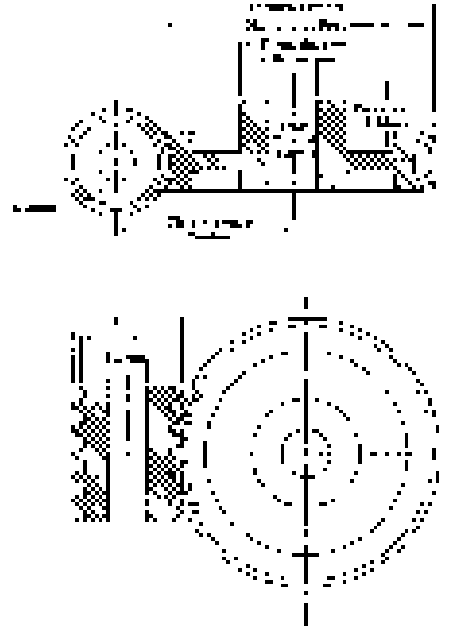

Hierro Fundido

Número de Dientes	Número de Parte Hierro Fundido	Peso Aprox. (lb)	Diám. de Paso	Barreno (Pulg.)	Maza (Pulg.)		Estilo
					Diám.	Proy.	
20	W820Q	1.2	2.500	1	2	$\frac{3}{8}$	SIMPLE
30	W830Q	2.5	3.750	1	2 $\frac{1}{2}$	$\frac{3}{8}$	W

W = ALMA



Acero — Sinfines con Ángulo de Hélice de $18^\circ 26'$

Número de Parte Suave	Peso Aprox. (lb)	Cara (Pulg.)	Paso Dia.	Barreno (Pulg.)	Maza (Pulg.)		Cuñero (Pulgadas)
					Diám.	Proy.	
W8Q	.58	$1\frac{1}{8}$	1.500	$\frac{3}{8}$	$1\frac{1}{8}$	$\frac{3}{8}$	$\frac{3}{16} \times \frac{3}{32}$
WH8Q	.76	$1\frac{1}{8}$	1.500	$\frac{3}{8}$	$1\frac{1}{8}$	$\frac{3}{8}$	

Los sinfines con la superficie endurecida tienen las cuerdas pulidas (Se indica con la letra "G" en el número de parte).
 Nota: Puede ser difícil modificar los barrenos existentes en los sinfines endurecidos.

Coronas y Sinfines

Paso 10 • Cara $\frac{5}{8}$ " • Ángulo de Presión $14\frac{1}{2}^\circ$

Cuerda Sencilla Mano Derecha (Sólo Mano Derecha en Existencia)

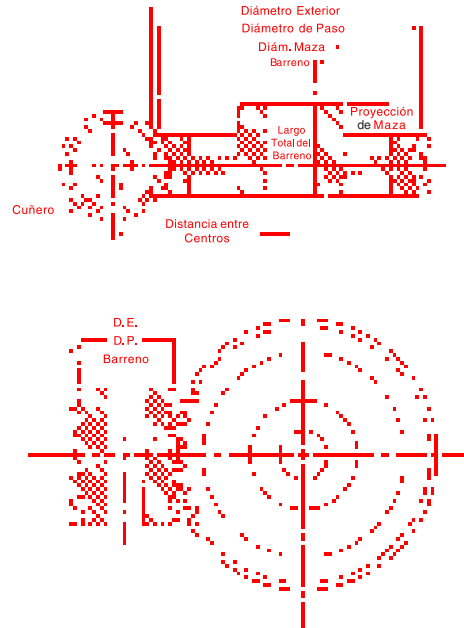

Hierro Fundido y Bronce

Número de Dientes	Número de Parte Hierro Fundido	Peso Aprox. (lb)	Diám. de Paso	Barreno (Pulg.)	Maza (Pulg.)		Estilo	Número de Parte Bronce	Peso Aprox. (lb)
					Diám.	Proy.			
20	W1020	.7	2.000	$\frac{1}{2}$	$1\frac{1}{4}$	$\frac{3}{4}$	PLANO	WB1020	.8
30	W1030	1.5	3.000	$\frac{5}{8}$	$1\frac{1}{4}$	$\frac{3}{4}$	PLANO	WB1030	1.7
40	W1040	1.8	4.000	$\frac{5}{8}$	$1\frac{1}{4}$	$\frac{3}{4}$	W	WB1040	2.4
50	W1050	2.8	5.000	$\frac{5}{8}$	2	$\frac{3}{4}$	W		
60	W1060	3.6	6.000	$\frac{5}{8}$	2	$\frac{3}{4}$	W		
80	W1080	4.8	8.000	$\frac{5}{8}$	2	$\frac{3}{4}$	W		
100	W10100	6.0	10.000	$\frac{5}{8}$	$2\frac{1}{2}$	$\frac{3}{4}$	W		

W = ALMA



Acero — Sinfines con Ángulo de Hélice de $4^\circ 34'$

Número de Parte Suave	Peso Aprox. (lb)	Número de Parte Endurecido	Peso Aprox. (lb)	Cara (Pulg.)	Diám. de Paso	Barreno (Pulg.)	Maza (Pulg.)		Cuñero (Pulgadas)
							Diám.	Proy.	
W10	.36	WG10	.32	$1\frac{1}{8}$	1.250	$\frac{5}{8}$			$\frac{3}{16} \times \frac{3}{32}$
WH10	.42		.38	$1\frac{1}{8}$	1.250	$\frac{5}{8}$	1	$\frac{1}{2}$	

Los sinfines con la superficie endurecida tienen las cuerdas pulidas (Se indica con la letra "G" en el número de parte).

Nota: Puede ser difícil modificar los barrenos existentes en los sinfines endurecidos.

Cuerda Doble Mano Derecha (Sólo Mano Derecha en Existencia)

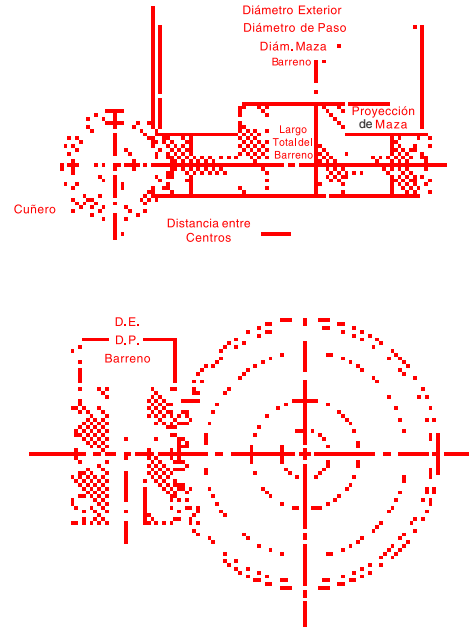

Hierro Fundido y Bronce

Número de Dientes	Número de Parte Hierro Fundido	Peso Aprox. (lb)	Diám. de Paso	Barreno (Pulg.)	Maza (Pulg.)		Estilo	Número de Parte Bronce	Peso Aprox. (lb)
					Diám.	Proy.			
20	W1020D	.65	2.000	$\frac{3}{8}$	1 $\frac{1}{2}$	$\frac{5}{8}$	PLANO	WB1020D WB1030D	.75
30	W1030D	1.3	3.000	$\frac{3}{8}$	1 $\frac{1}{2}$	$\frac{5}{8}$	PLANO		1.3
40	W1040D	1.6	4.000	$\frac{3}{8}$	1 $\frac{1}{2}$	$\frac{5}{8}$	W		
50	W1050D	2.9	5.000	$\frac{3}{8}$	2	1	W		
60	W1060D	3.0	6.000	$\frac{3}{8}$	2	1	W		

W = ALMA



Acero — Sinfines con Ángulo de Hélice de $9^\circ 5'$

Número de Parte Suave	Peso Aprox. (lb)	Cara (Pulg.)	Diám. de Paso	Barreno (Pulg.)	Maza (Pulg.)		Cuñero (Pulg.)
					Diám.	Proy.	
W10D	.28	1 $\frac{1}{8}$	1.2500	$\frac{3}{8}$	1	$\frac{1}{2}$	$\frac{3}{16} \times \frac{3}{32}$
WH10D	.42	1 $\frac{1}{8}$	1.2500	$\frac{3}{8}$	1	$\frac{1}{2}$	$\frac{3}{16} \times \frac{3}{32}$

Coronas y Sinfines

Paso 10 • Cara $\frac{5}{8}$ " • Ángulo de Presión $14\frac{1}{2}^\circ$

Cuerda Cuádruple Mano Derecha (Sólo Mano Derecha en Existencia)

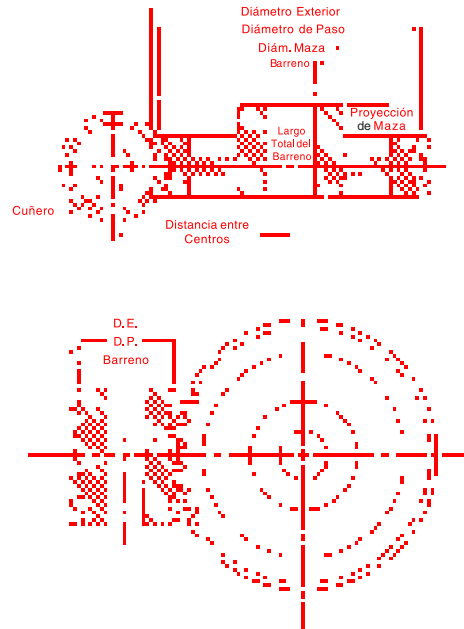

Hierro Fundido

Número de Dientes	Número de Parte Hierro Fundido	Peso Aprox. (lb)	Diám. de Paso	Barreno (Pulg.)	Maza (Pulg.)		Estilo
					Diám.	Proy.	
20	W1020Q	.64	2.000	$\frac{7}{8}$	1 $\frac{1}{2}$	$\frac{3}{4}$	SIMPLE
30	W1030Q	1.3	3.000	$\frac{7}{8}$	1 $\frac{1}{2}$	$\frac{3}{4}$	W
40	W1040Q	1.6	4.000	$\frac{7}{8}$	1 $\frac{1}{2}$	$\frac{3}{4}$	W

W = ALMA



Acero — Sinfines con Ángulo de Hélice de $17^\circ 45'$

Número de Parte Suave	Peso Aprox. (lb)	Cara (Pulg.)	Diám. de Paso	Barreno (Pulg.)	Maza (Pulg.)		Cuñero (Pulgadas)
					Diám.	Proy.	
W10Q	.28	1 $\frac{1}{2}$	1.250	$\frac{3}{4}$	1	$\frac{1}{2}$	$\frac{3}{16} \times \frac{3}{32}$
WH10Q	.40	1 $\frac{1}{2}$	1.250	$\frac{3}{4}$	1	$\frac{1}{2}$	$\frac{3}{16} \times \frac{3}{32}$

Cuerda Sencilla Mano Derecha (Sólo Mano Derecha en Existencia)

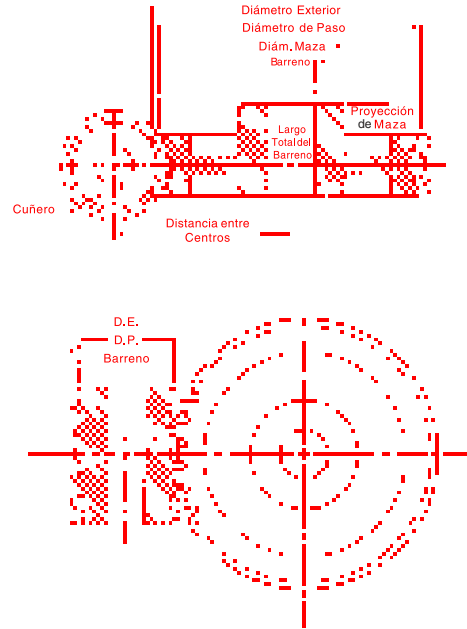

Hierro Fundido y Bronce

Número de Dientes	Número de Parte Hierro Fundido	Peso Aprox. (lb)	Diám. de Paso	Barreno (Pulg.)	Maza (Pulg.)		Estilo	Número de Parte Bronce	Peso Aprox. (lb)
					Diám.	Proy.			
18	W1218	.28	1.500	1/2	1 1/4	5/8	PLANO	WB1220	.45
20	W1220	.35	1.667	1/2	1 1/4	5/8	PLANO		
30	W1230	.71	2.500	1/2	1 1/4	5/8	W		
40	W1240	1.2	3.333	5/8	1 1/2	3/4	W		
50	W1250	1.5	4.166	5/8	1 1/2	3/4	W		
60	W1260	2.0	5.000	5/8	1 1/4	3/4	W		
80	W1280	3.9	6.666	5/8	2 1/2	3/4	W		
100	W12100	4.4	8.333	3/4	2	3/4	W		

W = ALMA



Acero — Sinfines con Ángulo de Hélice de 4° 46'

Número de Parte Suave	Peso Aprox. (lb)	Número de Parte Endurecido	Peso Aprox. (lb)	Cara (Pulg.)	Diám. de Paso	Barreno (Pulg.)	Maza (Pulg.)		Cuñero (Pulgadas)
							Diám.	Proy.	
W12	.17	WG12	.14	1 1/2	1.000	1/2			1/8 x 1/16
WH12	.20			1 1/2	1.000	1/2	5/8	5/8	

Los sinfines con la superficie endurecida tienen las cuerdas pulidas (Se indica con la letra "G" en el número de parte).
Nota: Puede ser difícil modificar los barrenos existentes en los sinfines endurecidos.

Coronas y Sinfines

Paso 12 • Cara 1/2" • Ángulo de Presión 14 1/2°

Cuerda Doble Mano Derecha (Sólo Mano Derecha en Existencia)

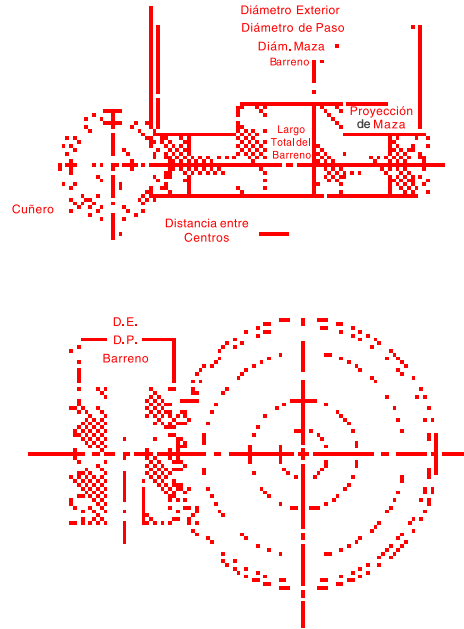

Hierro Fundido y Bronce

Número de Dientes	Número de Parte Hierro Fundido	Peso Aprox. (lb)	Diám. de Paso	Barreno (Pulg.)	Maza (Pulg.)		Estilo	Número de Parte Bronce	Peso Aprox. (lb)
					Diám.	Proy.			
20	W1220D	.32	1.666	1/2	1 1/4	1/2	SIMPLE	WB1220D	.40
30	W1230D	.78	2.500	3/4	1 1/2	5/8	SIMPLE		
40	W1240D	1.3	3.333	3/4	1 3/4	5/8	W		

W = ALMA



Acero — Sinfines con Ángulo de Hélice de 9° 28'

Número de Parte Suave	Peso Aprox. (lb)	Número de Parte Endurecido	Peso Aprox. (lb)	Cara (Pulg.)	Diám. de Paso	Barreno (Pulg.)	Maza (Pulg.)		Cuñero (Pulgadas)
							Diám.	Proy.	
W12D	.14	WG12D	.14	1 1/2	1.000	5/8	3/4	5/8	1/6 x 1/6
WH12D	.20			1 1/2	1.000	1/2	3/4	5/8	

Los sinfines con la superficie endurecida tienen las cuerdas pulidas (Se indica con la letra "G" en el número de parte).

Nota: Puede ser difícil modificar los barrenos existentes en los sinfines endurecidos.

Cuerda Cuádruple Mano Derecha (Sólo Mano Derecha en Existencia)

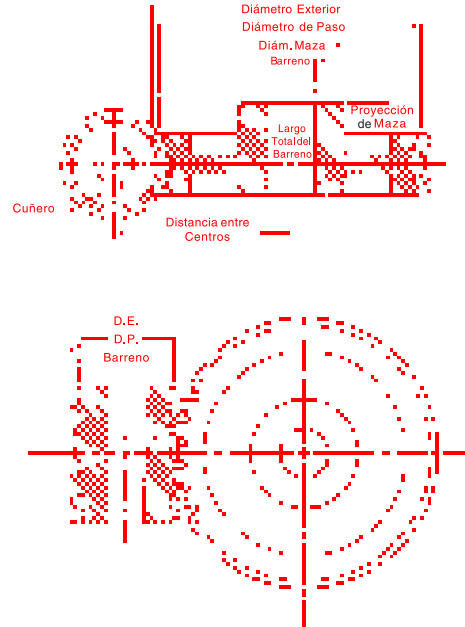

Hierro Fundido

Número de Dientes	Número de Parte Hierro Fundido	Peso Aprox. (lb)	Diám. de Paso	Barreno (Pulgadas)	Maza (Pulgadas)		Estilo
					Diám.	Proy.	
20	W1220Q	.32	1.666	1/2	1 1/4	1/2	SIMPLE
30	W1230Q	.38	2.500	3/4	1 1/2	3/4	SIMPLE
40	W1240Q	.80	3.333	3/4	1 3/4	3/4	W

W = ALMA



Acero — Sinfines con Ángulo de Hélice de 18° 26'

Número de Parte Suave	Peso Aprox. (lb)	Número de Parte Endurecido	Peso Aprox. (lb)	Cara (Pulgadas)	Diám. de Paso	Barreno (Pulgadas)	Maza (Pulgadas)		Cuñero (Pulgadas)
							Diám.	Proy.	
W12Q	.14	WG12Q	.14	1 1/4	1.000	3/8	3/8	3/8	1/8 x 1/16
WH12Q	.20			1 1/4	1.000	1/2	3/8	3/8	

Coronas y Sinfines

Paso 16 • Cara $\frac{5}{16}$ " • Ángulo de Presión $14\frac{1}{2}^\circ$

Cuerda Sencilla Mano Derecha (Sólo Mano Derecha en Existencia)

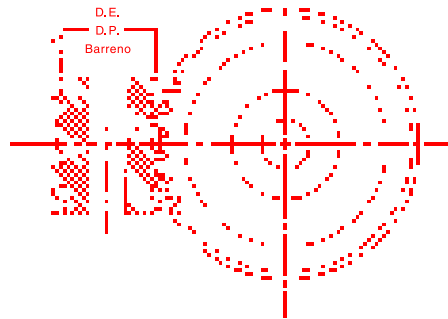
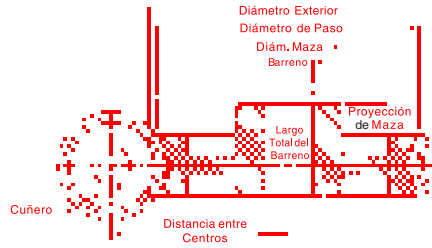

Bronce

Número de Dientes	Número de Parte	Peso Aprox. (lb)	Diám. de Paso	Barreno (Pulgadas)	Maza (Pulgadas)		Estilo
					Diám.	Proy.	
20	WB1620	.13	1.250	$\frac{1}{4}$	$\frac{5}{8}$	$\frac{5}{16}$	SIMPLE
30	WB1630	.28	1.875	$\frac{5}{16}$	$\frac{3}{4}$	$\frac{3}{8}$	W
40	WB1640	.42	2.500	$\frac{3}{8}$	$\frac{3}{4}$	$\frac{3}{8}$	W
50	WB1650	.50	3.125	$\frac{3}{8}$	$\frac{7}{8}$	$\frac{7}{16}$	W

W = ALMA



Acero — Sinfines con Ángulo de Hélice de $5^\circ 43'$

Número de Parte Suave	Peso Aprox. (lb)	Número de Parte Endurecido	Peso Aprox. (lb)	Cara (Pulgadas)	Diám. de Paso	Barreno (Pulgadas)	Maza (Pulgadas)	
							Diám.	Proy.
WH16	.08	WHG16	.07	1	.625	$\frac{1}{4}$.46	$\frac{1}{4}$
				1	.625	$\frac{5}{16}$.46	$\frac{1}{4}$

Los sinfines con la superficie endurecida tienen las cuerdas pulidas (Se indica con la letra "G" en el número de parte).

Nota: Puede ser difícil modificar los barrenos existentes en los sinfines endurecidos.

Cuerda Doble Mano Derecha (Sólo Mano Derecha en Existencia)

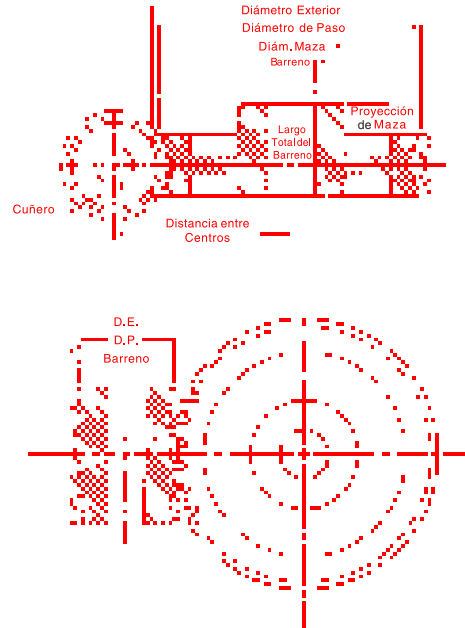

Bronce

Número de Dientes	Número de Parte	Peso Aprox. (lb)	Diám. de Paso	Barreno (Pulgadas)	Maza (Pulgadas)		Estilo
					Diám.	Proy.	
20	WB1620D	.14	1.250	$\frac{1}{4}$	$\frac{5}{8}$	$\frac{5}{16}$	SIMPLE

W = ALMA



Acero — Sinfines con Ángulo de Hélice de $11^\circ 19'$

Número de Parte Suave	Peso Aprox. (lb)	Cara (Pulg.)	Diám. de Paso	Barreno (Pulgadas)	Maza (Pulgadas)	
					Diám.	Proy.
WH16D	.09	1	.625	$\frac{1}{4}$.46	$\frac{1}{4}$

Coronas y Sinfines

Paso 16 • Cara $\frac{5}{16}$ " • Ángulo de Presión $14\frac{1}{2}^\circ$

Cuerda Quadruple Mano Derecha (Sólo Mano Derecha en Existencia)

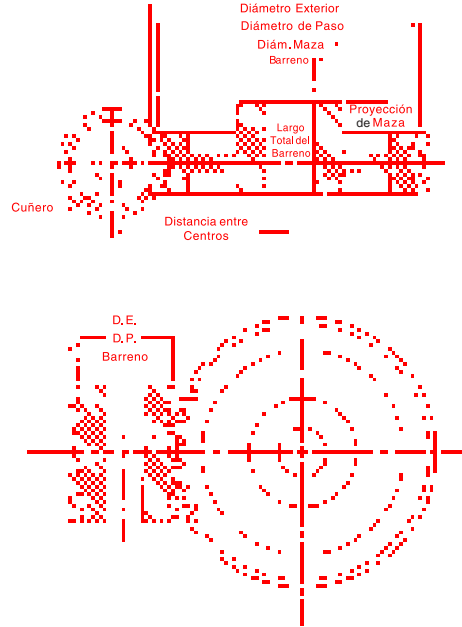

Bronce

Número de Dientes	Número de Parte	Peso Aprox. (lb)	Diám. de Paso	Barreno (Pulgadas)	Maza (Pulgadas)		Estilo
					Diám.	Proy.	
20	WB1620Q	.14	1.250	$\frac{1}{4}$	$\frac{5}{8}$	$\frac{5}{16}$	SIMPLE

W = ALMA



Acero — Sinfines con Ángulo de Hélice de $21^\circ 48'$

Número de Parte Suave	Peso Aprox. (lb)	Cara (Pulgadas)	Diám. de Paso	Barreno (Pulgadas)	Maza (Pulgadas)	
					Diám.	Proy.
WH16Q	.08	1	.625	$\frac{1}{4}$.46	$\frac{1}{4}$



Capacidad de Potencia HP de Coronas y Sinfines

Relaciones de Velocidad – Distancia entre Centros con Capacidad de Potencia (HP) y Torque Aproximados para Sinfines Endurecidos y Pulidos con Coronas de Bronce.

RPM del Sinfín			1800		900		300		100	
Centro		*Engrane	Entrada-Salida		Entrada-Salida		Entrada-Salida		Entrada-Salida	
Relación	Distancia		HP	Torque	HP	Torque	HP	Torque	HP	Torque
5	.938	WB1620Q	.37	60	.25	70	.09	80	.03	80
5	1.333	WB1220Q	.80	130	.55	170	.25	200	.08	215
5	1.625	WB1020Q	1.25	200	.90	275	.40	350	.15	370
5	2.000	WB820Q	2.00	315	1.50	460	.80	890	.33	965
5	2.667	WB620Q	3.70	600	2.75	880	1.40	1280	.55	1430
6	3.000	WB624Q	4.50	880	3.40	1300	1.75	1900	.70	2180
7.5	1.250	WB1630Q	.50	130	.33	160	.14	180	.05	185
7.5	1.750	WB1230Q	1.25	300	.85	390	.33	460	.13	490
7.5	2.125	WB1030Q	1.90	450	1.33	560	.60	790	.25	850
7.5	2.625	WB830Q	3.00	725	2.25	1060	1.00	1400	.40	1520
7.5	3.500	WB630Q	5.75	1400	4.33	2060	2.20	2960	.87	3330
9.67	4.050	WB529T	8.40	2615	6.25	3785	3.33	5730	1.33	6540
10	.938	WB1620D	.25	70	.15	85	.06	90	.02	95
10	1.333	WB1220D	.50	155	.33	205	.16	240	.06	250
10	1.562	WB1640Q	.75	240	.50	285	.18	320	.06	330
10	1.625	WB1020D	.80	230	.60	325	.25	400	.10	430
10	2.000	WB820D	1.25	365	.90	525	.45	690	.15	750
10	2.167	WB1240Q	1.67	530	1.10	700	.50	830	.17	880
10	2.625	WB1040Q	2.50	805	1.75	1120	.80	1400	.30	1500
10	2.667	WB620D	2.40	735	1.80	1075	.95	1540	.37	1700
10	3.250	WB840Q	4.00	1300	3.00	1880	1.40	2500	.50	2700
10	4.333	WB640Q	7.75	2500	5.75	3675	3.00	5333	1.15	5980
12	3.000	WB624D	2.85	1050	2.20	1550	1.15	2200	.45	2450
12.5	1.875	WB1650Q	.95	375	.60	445	.25	500	.08	515
12.5	2.583	WB1250Q	2.00	820	1.40	1080	.60	1300	.20	1370
12.5	3.125	WB1050Q	3.00	1250	2.25	1740	1.00	2200	.33	2340
12.5	3.875	WB850Q	4.90	2000	3.70	2900	1.70	3840	.65	4170
12.5	5.167	WB650Q	9.50	3800	7.00	5600	3.60	8200	1.40	9200
13.33	5.150	WB540T	11.00	4720	8.20	6830	4.40	10360	1.75	11800
15	1.250	WB1630D	.33	155	.25	180	.08	200	.03	210
15	1.750	WB1230D	.75	350	.50	450	.25	535	.07	560
15	2.125	WB1030D	1.20	520	.87	725	.37	900	.15	965
15	2.188	WB1660Q	1.10	570	.70	680	.25	760	.10	790
15	2.625	WB830D	1.67	750	1.25	1080	.60	1415	.25	1530
15	3.000	WB1260Q	2.50	1170	1.67	1540	.70	1800	.25	1930
15	3.500	WB630D	3.50	1620	2.70	2375	1.40	3370	.55	3770
15	3.625	WB1060Q	3.75	1700	2.67	2500	1.17	3100	.50	3300
15	4.500	WB860Q	5.75	2820	4.33	4100	2.00	5470	.75	6000
15	6.000	WB660Q	11.33	5550	8.50	8000	4.33	11700	1.70	13100
16.67	6.150	WB550T	13.50	7250	10.00	10500	5.40	16000	2.20	18000
18	5.000	WB318	6.00	3100	4.67	4570	3.00	8000	1.50	10000
18	7.000	WB672Q	13.50	7800	10.00	11400	5.00	16500	2.00	18500
20	.938	WB1620	.15	75	.10	90	.04	100	.02	105
20	1.333	WB1220	.33	170	.25	220	.10	260	.04	275
20	1.562	WB1640D	.50	270	.30	310	.10	350	.04	350
20	1.625	WB1020	.50	250	.33	350	.20	440	.07	470

* Las capacidades de potencia indicadas son para coronas de bronce operando con sinfines de acero endurecidos y pulidos. Para las capacidades de coronas de hierro fundido con sinfines de acero endurecido multiplique las capacidades de potencia por 30%. Para hierro fundido con sinfines de acero endurecido y pulido multiplique por 50%.

† Torque en libras-pulgada.

Capacidad de Potencia HP de Coronas y Sinfines



Relaciones de Velocidad – Distancia entre Centros con Capacidad de Potencia (HP) y Torque Aproximados para Sinfines Endurecidos y Pulidos con Coronas de Bronce.

RPM del Sinfín			1800		900		300		100	
Centro		* Engrane	Entrada-Salida		Entrada-Salida		Entrada-Salida		Entrada-Salida	
Relación	Distancia		HP	Torque	HP	Torque	HP	Torque	HP	Torque
20	2.000	WB820	.75	400	.60	600	.33	775	.12	850
20	2.167	WB1240D	1.00	600	.67	775	.33	920	.10	970
20	2.625	WB1040D	1.50	900	.85	1230	.50	1500	.20	1650
20	2.667	WB620	1.50	800	1.15	1170	.75	1660	.25	1850
20	2.812	WB1680Q	1.40	900	.90	1075	.33	1200	.12	1240
20	3.250	WB840D	2.30	1400	1.75	2000	.80	2580	.33	2800
20	3.833	WB1280Q	3.12	2000	2.12	2600	.90	3120	.33	3300
20	4.000	WB420	3.50	2000	2.75	2880	1.75	4700	.75	5600
20	4.333	WB640D	4.50	2780	3.40	4050	1.75	5800	.70	6500
20	4.625	WB1080Q	4.75	3000	3.40	4250	1.50	5340	.50	5700
20	5.750	WB880Q	7.50	4800	5.60	7000	2.60	9400	1.00	10200
20	7.667	WB680Q	15.00	9500	10.75	13800	5.50	20000	2.20	22500
24	3.000	WB624	1.75	1120	1.33	1630	.75	2300	.33	2600
24	4.500	WB424	4.00	2800	3.00	4000	2.00	6600	.90	7800
24	6.000	WB324	7.50	5300	5.90	7750	3.90	13500	1.90	17000
25	1.875	WB1650D	.50	370	.33	470	.12	520	.05	540
25	2.583	WB1250D	1.20	890	.80	1150	.33	1380	.12	1450
25	3.125	WB1050D	1.80	1340	1.33	1850	.60	2300	.25	2500
25	3.438	WB16100Q	1.75	1300	1.00	1575	.40	1750	.12	1800
25	3.875	WB850D	3.00	2200	2.25	3250	1.00	4200	.40	4500
25	4.667	WB12100Q	3.67	2800	2.50	3660	1.00	4400	.40	4630
25	5.167	WB650D	5.50	4000	4.00	6000	2.15	8700	.87	9700
25	5.625	WB10100Q	5.70	4500	4.10	6380	1.75	8000	.67	8500
25	7.000	WB8100Q	10.00	9700	7.00	11500	4.00	17500	1.25	19000
25	9.333	WB6100Q	17.50	14250	13.00	20750	6.66	30000	2.60	33000
29	4.050	WB529	3.50	2800	2.75	4200	1.50	6300	.67	7000
30	1.250	WB1630	.20	160	.12	190	.06	210	.02	215
30	1.750	WB1230	.50	350	.33	450	.15	540	.06	570
30	2.125	WB1030	.70	530	.50	750	.25	925	.10	1000
30	2.188	WB1660	.60	590	.40	700	.15	760	.05	800
30	2.625	WB830	1.00	870	.85	1260	.40	1600	.17	1750
30	3.000	WB1260D	1.33	1230	1.00	1600	.40	1900	.15	2000
30	3.500	WB630	2.00	1700	1.60	2430	.87	3500	.33	3800
30	3.625	WB1060D	2.00	1850	1.50	2500	.70	3200	.25	3430
30	4.500	WB860D	3.25	2900	2.50	4300	1.12	5650	.50	6000
30	6.000	WB660D	6.30	5800	4.80	6075	2.50	12110	1.00	13510
30	7.000	WB330	9.05	7880	7.00	11570	4.60	20280	2.25	25560
32	5.500	WB432	5.15	4680	4.00	6750	2.50	11140	1.10	13200
36	4.000	WB636	2.33	2310	1.80	3380	1.00	4800	.42	5360
36	7.000	WB672D	7.25	8010	5.50	11670	2.87	16700	1.15	18650
36	8.000	WB336	10.40	10900	8.10	15960	5.35	27950	2.60	35280
40	1.562	WB1640	.25	266	.12	330	.07	350	.02	360
40	2.167	WB1240	.55	580	.30	825	.18	900	.07	940
40	2.625	WB1040	.87	890	.65	1220	.30	1520	.12	1630
40	2.812	WB1680D	.75	910	.33	1140	.20	1200	.07	1230

* Las capacidades de potencia indicadas son para coronas de bronce operando con sinfines de acero endurecidos y pulidos. Para las capacidades de coronas de hierro fundido con sinfines de acero endurecido multiplique las capacidades de potencia por 30%. Para hierro fundido con sinfines de acero endurecido y pulido multiplique por 50%.

† Torque en libras-pulgada.

Relaciones de Velocidad – Distancia entre Centros con Capacidad de Potencia (HP) y Torque Aproximados para Sinfines Endurecidos y Pulidos con Coronas de Bronce.

RPM del Sinfín			1800		900		300		100	
Centro		*Engrane	Entrada-Salida		Entrada-Salida		Entrada-Salida		Entrada-Salida	
Relación	Distancia		HP	Torque	HP	Torque	HP	Torque	HP	Torque
40	3.250	WB840	1.35	1440	.85	2350	.50	2700	.20	2900
40	3.833	WB1280D	1.70	2040	1.15	2675	.50	3160	.20	3330
40	4.333	WB640	2.50	2770	2.00	4033	1.00	5760	.45	6420
40	4.625	WB1080D	2.60	3070	1.90	4270	.85	5315	.33	5680
40	5.150	WB540	4.33	4930	3.40	7145	2.00	10725	.83	12170
40	5.750	WB880D	4.00	4740	3.00	6850	1.40	8940	.55	9680
40	6.500	WB440	6.00	5520	4.65	7950	3.00	13200	1.33	15480
40	7.667	WB680D	7.83	9600	6.00	14000	3.00	20025	1.25	22340
48	3.750	WB848	1.50	1950	1.20	2820	.60	3650	.25	3960
48	5.000	WB648	2.80	3730	2.25	5460	1.25	7750	.50	8640
48	7.500	WB448	6.80	9320	5.25	13400	3.33	22200	1.50	26160
48	10.000	WB348	12.70	17640	9.87	25920	6.50	45360	3.16	57120
50	1.875	WB1650	.30	380	.20	450	.08	490	.03	515
50	2.583	WB1250	.66	840	.50	1090	.20	1300	.08	1360
50	3.125	WB1050	1.00	1280	.75	1770	.33	2200	.14	2340
50	3.438	WB16100D	.90	1290	.50	1525	.25	1690	.08	1730
50	3.875	WB850	1.60	2140	1.25	3130	.66	4090	.25	4430
50	4.667	WB12100D	2.00	2875	1.33	3600	.50	4460	.22	4700
50	5.167	WB650	2.90	4000	2.25	5825	1.25	8310	.50	9260
50	5.625	WB10100D	3.00	4440	2.16	6110	1.00	7675	.33	8000
50	6.150	WB550	5.12	7120	4.00	10320	2.25	15480	1.00	17570
50	7.000	WB8100D	4.10	5000	2.75	7500	1.50	8000	.60	10000
50	9.333	WB6100D	9.00	13800	6.75	20200	3.50	28930	1.40	32280
54	11.000	WB354	13.50	21230	10.50	31200	7.00	54480	3.33	68760
59	7.050	WB559	5.50	9230	4.50	13900	2.50	20075	1.00	23160
60	2.188	WB1660	.33	550	.20	650	.08	720	.03	740
60	3.000	WB1260	.75	1100	.50	1440	.25	1700	.09	1790
60	3.625	WB1060	1.00	1690	.80	2330	.33	2890	.16	3080
60	4.500	WB860	1.66	2660	1.33	3900	.66	5090	.25	5500
60	6.000	WB660	320 5240	2.50	7670 1.40	1080	.60	1225		
64	9.500	WB464	7.87	14280	6.00	20640	3.80	34080	1.70	40320
72	7.000	WB672	3.33	6610	2.50	9660	1.50	13700	.60	15360
80	2.812	WB1680	.33	705	.22	830	.09	920	.04	950
80	3.833	WB1280	.75	1550	.50	2030	.25	2375	.10	2520
80	4.625	WB1080	1.15	2375	.87	3275	.40	4050	.16	4330
80	5.750	WB880	1.80	3800	1.40	5500	.70	7140	.30	7750
80	7.667	WB680	3.33	7380	2.66	10750	1.50	15350	.60	17110
96	6.750	WB896	1.50	4200	1.00	6000	.50	7000	.20	8500
96	9.000	WB696	3.25	8490	2.50	12370	1.33	17660	.50	19680
100	3.438	WB16100	.33	810	.20	960	.09	1060	.33	1100
100	4.667	WB12100	.75	1790	.50	2330	.25	2730	.90	2800
100	5.625	WB10100	1.00	2780	.80	3850	.33	4775	.16	5100
100	7.000	WB8100	1.67	4450	1.25	6300	.67	8000	.24	9000
100	9.333	WB6100	3.20	8700	2.50	12675	1.33	18090	.55	20160

* Las capacidades de potencia indicadas son para coronas de bronce operando con sinfines de acero endurecidos y pulidos. Para las capacidades de coronas de hierro fundido con sinfines de acero endurecido multiplique las capacidades de potencia por 30%. Para hierro fundido con sinfines de acero endurecido y pulido multiplique por 50%.

† Torque en libras-pulgada.

Tolerancias Estándar de los Engranés



La calidad es el factor más importante para comprar un engrane. Hemos establecido Estándares y Tolerancias para suministrar a nuestros clientes engranes duraderos, precisos y confiables. Todos los engranes son revisados con pernos de precisión para asegurar que tienen el juego correcto y las distancias entre centros.

JUEGO: Todos los engranes en existencia son revisados entre centros para el juego. El juego recomendado para una pareja de engranes ensamblados es:

3 DP009 — .014	10 DP003 — .005
4 DP007 — .011	12 DP003 — .005
5 DP006 — .009	16 DP002 — .004
6 DP005 — .008	20 DP002 — .004
8 DP004 — .006	24 DP002 — .004

LA CONCENTRICIDAD de la línea de paso con el barreno (Lectura de Indicador Total) se mantiene dentro de:

3 DP006	10 DP004
4 DP006	12 DP004
5 DP005	16 DP0025
6 DP005	20 DP0025
8 DP005	24 DP0025

Los barrenos en existencia están joneados o pulidos para alcanzar un terminado uniforme que cumpla o que se apegue aun más a los estándares de las tolerancias comerciales requeridos. Para prevenir la oxidación en los anaqueles de los distribuidores y darles una mejor presentación para el usuario, todos los engranes en existencia pasan por un proceso de acabado especial. Su presentación es excelente en los mostradores y/o en los anaqueles. No se ponen en cajas. Todos los engranes están identificados por su número de parte.

**Datos de
Ingeniería
de Engranés**

**Engrane Recto
Fórmulas para Engranés
Selección de Transmisión
Tablas de Potencia (HP) y Torque**

Selección de Transmisión de Engranés



Selección de Transmisión de Engranés Rectos en Existencia

Cuando se diseñe una transmisión de engranes en existencia utilizando las tablas de capacidad de potencia de este catálogo, siga los siguientes pasos:

- I. Obtenga la siguiente información :
 - a. La distancia entre centros exacta en pulgadas
 - b. La relación de velocidad y las velocidades
 - c. El factor de Servicio (de la página G-84)
 - d. Potencia real en HP
 - e. Diámetros de barrenos de ambos engranes

- II. Determine la Potencia de Diseño en HP utilizando la siguiente fórmula:

$$DHP = HP \times FS$$

En donde: DHP = Potencia de Diseño

HP= HP real

FS = Factor de Servicio (página G-84)

- III. Determine los Diámetros de Paso utilizando las siguientes fórmulas:

$$DP_1 = \frac{DC \times 2}{\text{Relación} + 1}$$

$$DP_2 = DP_1 \times \text{Relación}$$

En Donde: DP_1 = Diámetro de Paso del Piñón (engrane pequeño)

DP_2 = Diámetro de Paso del Engrane (engranaje mayor)

DC = Distancia entre Centros.

- IV. Revise la Distancia Entre Centros

$$DC = \frac{DP_1 + DP_2}{2}$$

- V. Seleccione el Paso con las tablas de Capacidad de Potencia de las páginas G-25 a G-27.
- VI. Revise el paso seleccionado para encontrar los diámetros de paso necesarios.
- VII. Revise la capacidad de Potencia del engrane mayor.
- VIII. Revise los barrenos máximos de los engranes seleccionados.

Selección II de Transmisión de Engranés Rectos (Fuera de Línea)

Cuando la potencia (HP) y las velocidades exceden las indicadas en las Tablas de Capacidad de Potencia de las Páginas G-25 – G-27, siga los siguientes pasos para diseñar la transmisión de engranes.

I. Obtenga la siguiente información:

- Distancia entre centros exacta en pulgadas.
- La relación de velocidad y las velocidades.
- El factor de Servicio (de la página G-84).
- Potencia real en HP
- Diámetros de barrenos de ambos engranes

II. Determine la Potencia de Diseño en HP utilizando la siguiente fórmula:

$$DHP = HP \times FS$$

En Donde: DHP = Potencia de Diseño

HP = HP real.

FS = Factor de Servicio (Página G-84)

V. Determine el paso aproximado utilizando la fórmula:

$$PD = \frac{3.1416 \times S \times 3 \times V \times .25}{\sqrt{DHP \times 27.5 (1200 + V)}}$$

Donde: PD = Paso diametral

S = Estrés Estático Seguro por pulgada cuadrada de material (vea Tabla uno, pág. G-84)

V = Velocidad en pies por minuto

DHP = Potencia de diseño (HP)

Nota: Para redondear resultados, use el PD más cercano (Los PD estándar mayores a 3DP son: 1 PD, 1¼ PD, 1½ PD, 1¾ PD, 2 PD, 2½ PD)

III. Determine los diámetros de Paso utilizando las siguientes fórmulas:

$$DP_1 = \frac{CD \times 2}{Relación + 1}$$

$$DP_2 = DP_1 \times Relación$$

En Donde: DP₁ = Diámetro de paso del piñón (engrane pequeño)

DP₂ = Diámetro de paso del engrane (engrane mayor)

DC = Distancia entre Centros

VI. Determine el número de dientes de los dos engranes:

$$N = DP \times PD$$

Donde: N = Número de Dientes

DP = Diámetro de Paso del engranaje

PD = Paso Diametral del engrane

IV. Calcule la velocidad utilizando la siguiente fórmula:

$$V = 0.262 \times DP \times RPM$$

En Donde: V = Velocidad en pies por minuto en la línea de paso

DP = Diámetro de Paso

RPM = Revoluciones por minuto de cualquier engrane*

* Nota: Las velocidades de ambos engranes siempre será la misma. Al usar la fórmula anterior asegúrese que está usando la velocidad adecuada (RPM) con el diámetro de paso correspondiente.

Selección II de Transmisión de Engranés Rectos (Fuera de Línea)

VII. Determine el ancho de cara:

$$F = PD \left(\frac{DHP \times 33,000}{V} \right) \frac{1}{SY \left(\frac{600}{600 + V} \right)}$$

Donde: F = Ancho de Cara

PD = Paso Diametral

V = Velocidad en Pies por Minuto

S = Estrés Estático Seguro por pulgada cuadrada de material (Tabla 1, página G-84)

Y = Factor de perfil de la tabla 2 página G-84

Nota: Redondee el resultado al siguiente número entero.

VIII. Revise la capacidad de potencia (HP) del piñón seleccionado utilizando la siguiente fórmula:

$$HP = \frac{LV}{33,000}$$

Donde: $L = \frac{SYF}{PD} \times \frac{600}{600 + V}$

De las fórmulas de potencia (HP) de la página G-83.

Nota: Si la capacidad de potencia (HP) es menor que la potencia de diseño, se tienen las siguientes opciones:

- A. Endurezca el piñón (revise primero la capacidad de potencia del engrane).
- B. Aumente el ancho de la cara.
- C. Aumente el paso del engrane.

Distancia entre Centros, Diámetro de Paso y Relación de Engranés Rectos

Para determinar los diámetros de paso de un juego de engranes, debemos tener la siguiente información:

1. Relación de velocidad
2. Distancia entre centros

Conociendo lo anterior, obtenemos el diámetro de paso del piñón (engrane pequeño) con la siguiente fórmula:

$$DP_1 = \frac{DC \times 2}{Relación + 1}$$

Donde: DP_1 = Diámetro de Paso del piñón

DC = Distancia entre Centros

Con esta información podemos obtener el diámetro de paso del engrane mayor, DP_2 , utilizando la siguiente fórmula:

$$DP_2 = DP_1 \times Relación$$

La distancia entre centros se calcula con la siguiente fórmula:

$$DC = \frac{DP_1 + DP_2}{2}$$

Fórmulas de Potencia (HP)

Vea la página G-84 para las tablas uno, dos y tres

Datos de Ingeniería

Formula Lewis (con revisión de Barth)

L = Carga en Libras en la Línea de Paso

S = Estrés Estático Seguro por Pulgada Cuadrada de Material (vea la tabla 1)

PD = Paso Diametral

F = Ancho de Cara del Engranaje

Y = Factor de Resistencia Basado en el Angulo de presión y el Números de Dientes (vea la tabla 2)

V = Velocidad en Pies por Minuto

$$V = .262 \times DP \times RPM$$

DP = Diámetro de Paso

RPM = Revoluciones por Minuto

HP = Potencia en Caballos de Fuerza

$$L = \frac{SFY \times 600}{PD \times (600 + V)}$$

El torque máximo permitido (T) que debe ser impuesto a un engrane es la carga segura del diente (L) multiplicada por

$$\frac{PD}{2} = T = \frac{L \times DP}{2}$$

La capacidad de potencia (HP) segura de un engrane (a determinadas RPM)

puede ser calculada de $HP = \frac{T \times RPM}{63,025}$

o directamente de (L) y (V):

$$*HP = \frac{LV}{33,000}$$

Para una potencia conocida (HP), $T = \frac{63025 \times HP}{RPM}$

Para ENGRANES NO METÁLICOS, la fórmula modificada de Lewis mostrada abajo puede ser utilizada con valores (S) de 6000 PSI para material Fenólico Laminado.

$$L = \frac{SFY}{PD} \left(\frac{150}{200 + V} + .25 \right)$$

* Aplique el factor de Servicio (Tabla tres) para obtener la potencia requerida.

Estándares de Engranés



Tabla I
(S) Valores promedio en libras por pulgada cuadrada

Material	S
Acero — Carbón .40	25000
— Carbón .20	20000
Acero — .40 Carbón, con Tratamiento Térmico	35000
Hierro Fundido	12000
Bronce	10000
No Metálico	6000

Tabla II
Factor de perfil Y para uso con paso diametral

Número de Dientes	A.P. 14½ Involuta	A.P. 20 Involuta	Número de Dientes	A.P. 14½ Involuta	A.P. 20 Involuta
10	.176	.201	26	.308	.344
11	.192	.226	28	.314	.352
12	.210	.245	30	.318	.358
13	.223	.264	35	.327	.373
14	.235	.276	40	.336	.389
15	.245	.289	45	.340	.399
16	.255	.295	50	.346	.408
17	.264	.302	60	.355	.421
18	.270	.308	70	.360	.429
19	.277	.314	80	.363	.436
20	.283	.320	90	.366	.442
21	.289	.326	100	.368	.446
22	.292	.330	150	.375	.458
23	.296	.333	200	.378	.463
24	.302	.337	CREMALLERA	.390	.484
25	.305	.340			

Tabla III
Factores de servicio
Multiplique la potencia (HP) requerida por el factor de servicio recomendado.

Tipo de Carga	Intermitente o 3 Horas al Día	8 a 10 Horas al Día	Continuo 24 Horas al Día
UNIFORME	.80	1.00	1.25
IMPACTO LIGERO	1.00	1.25	1.50
IMPACTO MEDIO	1.25	1.50	1.80
IMPACTO MODERADO	1.50	1.80	2.00

Reglas y Fórmulas Para Cálculos de Engranés Rectos

El Paso Diametral es el número de dientes por cada pulgada del diámetro de paso

Para encontrar	Teniendo	Regla	Fórmula
Paso Diametral	El Paso Circular	Divida 3.1416 entre el Paso Circular	$PD = \frac{3.1416}{PC}$
Paso Diametral	El Diámetro de Paso y el Número de Dientes	Divida el Número de Dientes entre el Diámetro de Paso	$PD = \frac{N}{DP}$
Paso Diametral	El Diámetro Exterior y el Número de Dientes	Divida el Número de Dientes más 2 entre el Diámetro Exterior	$PD = \frac{N+2}{DE}$
Diámetro de Paso	El Número de Dientes y el Paso Diametral	Divida el Número de Dientes entre el Paso Diametral	$DP = \frac{N}{PD}$
Diámetro de Paso	El Número de Dientes y el Diámetro Exterior	Divida el producto del Diámetro Exterior y el Número de Dientes entre el Número de Dientes más 2	$DP = \frac{DE \times N}{N+2}$
Diámetro de Paso	El Diámetro Exterior y el Paso Diametral	Restar del Diámetro Exterior el cociente de 2 dividido entre el Paso Diametral	$DP = DE - \frac{2}{PD}$
Diámetro de Paso	Adendum y el Número de Dientes	Multiplique el adendum por el Número de Dientes	$DP = sN$
Diámetro Exterior	El Número de Dientes y el Paso Diametral	Divida el Número de Dientes más 2 entre el Paso Diametral	$DE = \frac{N+2}{PD}$
Diámetro Exterior	El Diámetro de Paso y el Paso Diametral	Sume al Diámetro de Paso el cociente de 2 dividido entre el Paso Diametral	$DE = DP + \frac{2}{PD}$
Diámetro Exterior	El Diámetro de Paso y el Número de Dientes	Divida el Número de Dientes más 2 entre el cociente del Número de Dientes entre el Diámetro de Paso	$DE = \frac{N+2}{N:DP}$
Diámetro Exterior	El Número de Dientes y el Adendum	Multiplique el Número de Dientes más 2 por el Adendum	$DE = (N+2)s$
Número de Dientes	El Diámetro de Paso y el Paso Diametral	Multiplique el Diámetro de Paso por el Paso Diametral	$N = DP \times PD$
Número de Dientes	El Diámetro Exterior y el Paso Diametral	Multiplique el Diámetro Exterior por el Paso Diametral y reste 2	$N = (DE \times PD) - 2$
Espesor del Diente	El Paso Diametral	Divida 1.5708 entre el Paso Diametral	$t = \frac{1.5708}{PD}$
Adendum	El Paso Diametral	Divida 1 entre el Paso Diametral	$A = \frac{1}{PD}$
Dedendum	El Paso Diametral	Divida 1.157 entre el Paso Diametral	$A+L = \frac{1.157}{PD}$
Profundidad de Trabajo	El Paso Diametral	Divida 2 entre el Paso Diametral	$PT = \frac{2}{PD}$
Profundidad Total	El Paso Diametral	Divida 2.157 entre el Paso Diametral	$PT' = \frac{2.157}{PD}$
Claro	El Paso Diametral	Divida .157 entre el Paso Diametral	$L = \frac{.157}{PD}$
Claro	Espesor del Diente	Divida el espesor del diente en la línea de paso entre 10	$L = \frac{t}{10}$

NOTA: Las reglas y fórmulas relacionadas a la profundidad del Diente y al Diámetro Exterior se aplican a Engranés de Adendum y de Profundidad Total iguales.

Dimensiones de Dientes - Paso Diametral



Dimensiones de Profundidad Total para Dientes Estándar

Pasos Diametrales y Pasos Circulares Equivalentes

Paso Diametral	Paso Circular	Módulo	Espesor del Arco Del Diente sobre la Línea de Paso	Adendum	Profundidad de Trabajo del Diente	Dedendum ó Profundidad de Espacio Debajo de la Línea de Paso	Profundidad Total del Diente*
1/2	6.2832	50.8	3.1416	2.0000	4.0000	2.3142	4.3142
3/4	4.1888	33.8667	2.0944	1.3333	2.6666	1.5428	2.8761
1	3.1416	25.4	1.5708	1.0000	2.0000	1.1571	2.1571
1 1/4	2.5133	20.32	1.2566	0.8000	1.6000	0.9257	1.7257
1 1/2	2.0944	16.9333	1.0472	0.6666	1.3333	0.7714	1.4381
1 3/4	1.7952	14.5143	0.8976	0.5714	1.1429	0.6612	1.2326
2	1.5708	12.7	0.7854	0.5000	1.0000	0.5785	1.0785
2 1/4	1.3963	11.2889	0.6981	0.4444	0.8888	0.5143	0.9587
2 1/2	1.2566	10.16	0.6283	0.4000	0.8000	0.4628	0.8628
2 3/4	1.1424	9.2364	0.5712	0.3636	0.7273	0.4208	0.7844
3	1.0472	8.4667	0.5236	0.3333	0.6666	0.3857	0.7190
3 1/2	0.8976	7.2571	0.4488	0.2857	0.5714	0.3306	0.6163
4	0.7854	6.35	0.3927	0.2500	0.5000	0.2893	0.5393
5	0.6283	5.08	0.3142	0.2000	0.4000	0.2314	0.4314
6	0.5236	4.2333	0.2618	0.1666	0.3333	0.1928	0.3595
7	0.4488	3.6286	0.2244	0.1429	0.2857	0.1653	0.3081
8	0.3927	3.175	0.1963	0.1250	0.2500	0.1446	0.2696
9	0.3491	2.8222	0.1745	0.1111	0.2222	0.1286	0.2397
10	0.3142	2.54	0.1571	0.1000	0.2000	0.1157	0.2157
11	0.2856	2.3091	0.1428	0.0909	0.1818	0.1052	0.1961
12	0.2618	2.1167	0.1309	0.0833	0.1666	0.0964	0.1798
13	0.2417	1.9538	0.1208	0.0769	0.1538	0.0890	0.1659
14	0.2244	1.8143	0.1122	0.0714	0.1429	0.0826	0.1541
15	0.2094	1.6933	0.1047	0.0666	0.1333	0.0771	0.1438
16	0.1963	1.5875	0.0982	0.0625	0.1250	0.0723	0.1348
17	0.1848	1.4941	0.0924	0.0588	0.1176	0.0681	0.1269
18	0.1745	1.4111	0.0873	0.0555	0.1111	0.0643	0.1198
19	0.1653	1.3368	0.0827	0.0526	0.1053	0.0609	0.1135
20	0.1571	1.27	0.0785	0.0500	0.1000	0.0579	0.1079
22	0.1428	1.1545	0.0714	0.0455	0.0909	0.0526	0.0980
24	0.1309	1.0583	0.0654	0.0417	0.0833	0.0482	0.0898
26	0.1208	.9769	0.0604	0.0385	0.0769	0.0445	0.0829
28	0.1122	.9071	0.0561	0.0357	0.0714	0.0413	0.0770
30	0.1047	.8467	0.0524	0.0333	0.0666	0.0386	0.0719
32	0.0982	.7938	0.0491	0.0312	0.0625	0.0362	0.0674
34	0.0924	.7471	0.0462	0.0294	0.0588	0.0340	0.0634
36	0.0873	.7056	0.0436	0.0278	0.0555	0.0321	0.0599
38	0.0827	.6684	0.0413	0.0263	0.0526	0.0304	0.0568
40	0.0785	.635	0.0393	0.0250	0.0500	0.0289	0.0539

*NOTA: Las dimensiones indicadas son sólo para DIENTES GENERADOS CON CORTADOR DE ENGRANES. Los dientes cortados con otro método pueden ser un poco más grandes. Consulte a *Martin* para las dimensiones exactas.

Todos los Engranajes en Existencia son de Paso Diametral

Reglas y Fórmulas Para Cálculos de Engranés Rectos

Paso Circular

Paso Circular es la Distancia del Centro de Un Diente al Centro del Siguiete Diente, Medido a través del Círculo del Paso

Para encontrar	Teniendo	Regla	Fórmula
Paso Circular	El Paso Diametral	Divida 3.1416 entre el Paso Diametral	$PC = \frac{3.1416}{PD}$
Paso Circular	El Diámetro de Paso y el Número de Dientes	Divida el Diámetro de Paso por el producto de .3183 y Número de Dientes	$PC = \frac{DP}{.3183N}$
Paso Circular	El Diámetro Exterior y el Número de Dientes	Divida el Diámetro Exterior entre el producto de .3183 y el Número de Dientes más 2	$PC = \frac{DE}{.3183 N + 2}$
Diámetro de Paso	El Número de Dientes y el Paso Circular	El producto continuo del Número de Dientes, el Paso Circular y .3183	$DP = N \times PC \cdot 3183$
Diámetro de Paso	El Número de Dientes y el Diámetro Exterior	Divida el producto del Número de Dientes y el Diámetro Exterior entre el Número de Dientes más 2	$DP = \frac{N \times DE}{N + 2}$
Diámetro de Paso	El Diámetro Exterior y el Paso Circular	Sustraer del Diámetro Exterior el producto del Paso Circular y .6366	$DP = DE - (PC \cdot .6366)$
Diámetro de Paso	Adendum y el Número de Dientes	Multiplique el Número de Dientes por el Adendum	$DP = N \times A$
Diámetro Exterior	El Número de Dientes y el Paso Circular	El producto continuo del Número de Dientes más 2, el Paso Circular y .3183	$DE = (N + 2) PC \times .3183$
Diámetro Exterior	El Diámetro de Paso y el Paso Circular	Sume al Diámetro de Paso el producto del Paso Circular y .6366	$DE = DP + (PC \times .6366)$
Diámetro Exterior	El Número de Dientes y el Adendum	Multiplique el Adendum por el Número de Dientes más 2	$DE = A (N + 2)$
Número de Dientes	El Diámetro de Paso y el Paso Circular	Divida el producto del Diámetro de Paso y 3.1416 entre el Paso Circular	$N = \frac{D + 3.1416}{PC}$
Espesor de Diente	El Paso Circular	Un Medio del Paso Circular	$t = \frac{PC}{2}$
Adendum	El Paso Circular	Multiplique el Paso Circular por .3183 ó $s = \frac{D'}{N}$	$A = PC \times .3183$
Dedendum	El Paso Circular	Multiplique el Paso Circular por .3683	$A + L = PC \times .3683$
Profundidad de Trabajo	El Paso Circular	Multiplique el Paso Circular por .6366	$PT = PC \times 0.6366$
Profundidad Total	El Paso Circular	Multiplique Paso Circular por .6866	$PT' = PC \times 0.6866$
Claro	El Paso Circular	Multiplique el Paso Circular por .05	$L = PC \times 0.05$
Claro	Espesor del Diente	Una décima del espesor del diente en la línea de paso	$L = \frac{t}{10}$

NOTA: Las reglas y fórmulas relacionadas a la profundidad del Diente y al Diámetro Exterior se aplican a Engranés de Adendum y de Profundidad Total iguales.

Los Engranés de Paso Circular son Hechos sobre Pedido

Dimensiones de Dientes - Paso Circular



Dimensiones de Profundidad Total para Dientes Estándar

Pasos Circulares y Pasos Diametrales Equivalentes

Paso Circular	Paso Diametral	Módulo	Espesor del Arco del Diente sobre la Línea de Paso	Adendum	Profundidad de Trabajo del Diente	Deendum ó Profundidad de Espacio Debajo de la Línea de Paso	Profundidad Total del Diente
4	0.7854	32.3402	2.0000	1.2732	2.5464	1.4732	2.7464
3½	0.8976	28.2581	1.7500	1.1140	2.2281	1.2890	2.4031
3	1.0472	24.2552	1.5000	0.9549	1.9098	1.1049	2.0598
2¾	1.1424	22.2339	1.3750	0.8753	1.7506	1.0128	1.8881
2½	1.2566	20.2117	1.2500	0.7957	1.5915	0.9207	1.7165
2¼	1.3963	18.1913	1.1250	0.7162	1.4323	0.8287	1.5448
2	1.5708	16.1701	1.0000	0.6366	1.2732	0.7366	1.3732
1¾	1.6755	15.1595	0.9375	0.5968	1.1937	0.6906	1.2874
1½	1.7952	14.1488	0.8750	0.5570	1.1141	0.6445	1.2016
1¼	1.9333	13.1382	0.8125	0.5173	1.0345	0.5985	1.1158
1½	2.0944	12.1276	0.7500	0.4775	0.9549	0.5525	1.0299
1⅙	2.1855	11.6223	0.7187	0.4576	0.9151	0.5294	0.9870
1⅝	2.2848	11.1169	0.6875	0.4377	0.8754	0.5064	0.9441
1⅞	2.3936	10.6116	0.6562	0.4178	0.8356	0.4834	0.9012
1¾	2.5133	10.1062	0.6250	0.3979	0.7958	0.4604	0.8583
1⅝	2.6456	9.6010	0.5937	0.3780	0.7560	0.4374	0.8154
1½	2.7925	9.0958	0.5625	0.3581	0.7162	0.4143	0.7724
1⅙	2.9568	8.5904	0.5312	0.3382	0.6764	0.3913	0.7295
1	3.1416	8.0851	0.5000	0.3183	0.6366	0.3683	0.6866
⅞	3.3510	7.5798	0.4687	0.2984	0.5968	0.3453	0.6437
¾	3.5904	7.0744	0.4375	0.2785	0.5570	0.3223	0.6007
⅝	3.8666	6.5692	0.4062	0.2586	0.5173	0.2993	0.5579
⅜	4.1888	6.0639	0.3750	0.2387	0.4775	0.2762	0.5150
⅙	4.5696	5.5586	0.3437	0.2189	0.4377	0.2532	0.4720
⅝	4.7124	5.3903	0.3333	0.2122	0.4244	0.2455	0.4577
⅜	5.0265	5.0532	0.3125	0.1989	0.3979	0.2301	0.4291
⅙	5.5851	4.5479	0.2812	0.1790	0.3581	0.2071	0.3862
½	6.2832	4.0426	0.2500	0.1592	0.3183	0.1842	0.3433
⅙	7.1808	3.5373	0.2187	0.1393	0.2785	0.1611	0.3003
⅝	7.8540	3.2340	0.2000	0.1273	0.2546	0.1473	0.2746
⅜	8.3776	3.0319	0.1875	0.1194	0.2387	0.1381	0.2575
⅙	9.4248	2.6947	0.1666	0.1061	0.2122	0.1228	0.2289
⅝	10.0531	2.5266	0.1562	0.0995	0.1989	0.1151	0.2146
⅜	10.9956	2.3100	0.1429	0.0909	0.1819	0.1052	0.1962
¼	12.5664	2.0213	0.1250	0.0796	0.1591	0.0921	0.1716
⅝	14.1372	1.7967	0.1111	0.0707	0.1415	0.0818	0.1526
⅜	15.7080	1.6170	0.1000	0.0637	0.1273	0.0737	0.1373
⅙	16.7552	1.5160	0.0937	0.0597	0.1194	0.0690	0.1287
⅝	18.8496	.5053	0.0833	0.0531	0.1061	0.0614	0.1144

Los Engranés de Paso Circular son Hechos sobre Pedido

Reglas y Fórmulas Para Cálculos de Engranés Rectos de Paso Modular (Métrico)

(El módulo representa la cantidad de diámetro de paso por diente)

Para encontrar	Teniendo	Regla	Fórmula
Módulo Métrico	El Diámetro de Paso y el Número de Dientes	Divida el Diámetro de Paso en Milímetros entre el Número de Dientes	$M = \frac{DP \text{ (Milímetros)}}{N}$
Módulo Métrico	El Paso Circular en Milímetros	Divida el Paso Circular en Milímetros entre Pi (3.1416)	$M = \frac{PC \text{ (Milímetros)}}{3.1416}$
Módulo Métrico	El Paso Diametral	Divida 25.4 entre Paso Diametral	$PD = \frac{25.4}{PD}$
Módulo Métrico	El Diámetro Exterior y el Número de Dientes	Divida el Diámetro Exterior (en Milímetros) entre el Número de Dientes más 2	$M = \frac{DE}{N + 2}$
Diámetro de Paso	El Módulo y el Número de Dientes	Multiplique el Módulo entre el Número de Dientes	$DP \text{ (en MM)} = M \times N$
Diámetro de Paso	El Diámetro Exterior y el Número de Dientes	Divida el producto del Diámetro Exterior y el Número de Dientes entre el Número de Dientes más 2	$DP = \frac{DE \times N}{N + 2}$
Diámetro de Paso	Diámetro Exterior y Módulo	Multiplique el Módulo por 2 y réstelo del Diámetro Exterior	$DP = DE - 2M$
Diámetro Exterior	El Número de Dientes y el Módulo	El Número de Dientes más 2 Multiplicado por el Módulo	$DE \text{ (en MM)} = (N + 2) \times M$
Paso Diametral	El Módulo	Divide 25.4 entre el Módulo	$PD = \frac{25.4}{M}$
Paso Circular	El Módulo	Multiplique el Módulo por Pi (3.1416)	$PC \text{ (en MM)} = M \times 3.1416$
Adendum	El Módulo conocido	El Adendum es igual al Módulo	$A = M$
Profundidad Total	El Módulo conocido	Multiplique 2.157 por el Módulo	$D'' \text{ (en MM)} = 2.157 \times M$
Espesor de Diente	El Módulo y Diámetro Exterior	Multiplique el Diámetro de Paso (en Milímetros) Por el Seno del Ángulo de 90 Dividido entre el Número de Dientes	$t \text{ (en MM)} = DP \times \text{Sen} \frac{90}{N}$
Módulo Inglés	Diámetro de Paso en pulgadas y Número de Dientes	Divida el Diámetro de Paso en Pulgadas entre el Número de Dientes	$M = \frac{DP \text{ (Pulgadas)}}{N}$ (Respuesta en Fracción)

NOTA: Las reglas y fórmulas relacionadas a la profundidad del Diente y al Diámetro Exterior se aplican a Engranés de Adendum y de Profundidad Total iguales.

Dimensiones de Dientes - Paso Modular



Dimensiones de Dientes en el Sistema Modular (Un milímetro es igual a 0.03937 pulgadas)

Módulo, Series Estándar DIN	Paso Diámetro Equivalente	Paso Circular		Adendum mm. †	Dedendum mm. †	Profundidad Total, mm. ‡	Profundidad Total, mm. ‡
		Milímetros	Pulgadas				
0.3	84.667	0.943	0.0371	0.30	0.35	0.650	0.647
0.4	63.500	1.257	0.0495	0.40	0.467	0.867	0.863
0.5	50.800	1.571	0.0618	0.50	0.583	1.083	1.079
0.6	42.333	1.885	0.0742	0.60	0.700	1.300	1.294
0.7	36.286	2.199	0.0865	0.70	0.817	1.517	1.510
0.8	31.750	2.513	0.0989	0.80	0.933	1.733	1.726
0.9	28.222	2.827	0.1113	0.90	1.050	1.950	1.941
1	25.400	3.142	0.1237	1.00	1.167	2.167	2.157
1.25	20.320	3.927	0.1546	1.25	1.458	2.708	2.697
1.5	16.933	4.712	0.1855	1.50	1.750	3.250	3.236
1.75	14.514	5.498	0.2164	1.75	2.042	3.792	3.774
2	12.700	6.283	0.2474	2.00	2.333	4.333	4.314
2.25	11.289	7.069	0.2783	2.25	2.625	4.875	4.853
2.5	10.160	7.854	0.3092	2.50	2.917	5.417	5.392
2.75	9.236	8.639	0.3401	2.75	3.208	5.958	5.932
3	8.466	9.425	0.3711	3.00	3.500	6.500	6.471
3.25	7.815	10.210	0.4020	3.25	3.791	7.041	7.010
3.5	7.257	10.996	0.4329	3.50	4.083	7.583	7.550
3.75	6.773	11.781	0.4638	3.75	4.375	8.125	8.089
4	6.350	12.566	0.4947	4.00	4.666	8.666	8.628
4.5	5.644	14.137	0.5566	4.50	5.25	9.750	9.707
5	5.080	15.708	0.6184	5.00	5.833	10.833	10.785
5.5	4.618	17.279	0.6803	5.50	6.416	11.916	11.864
6	4.233	18.850	0.7421	6.00	7.000	13.000	12.942
6.5	3.908	20.420	0.8035	6.50	7.583	14.083	14.021
7	3.628	21.991	0.8658	7.00	8.166	15.166	15.099
8	3.175	25.132	0.9895	8.00	9.333	17.333	17.256
9	2.822	28.274	1.1132	9.00	10.499	19.499	19.413
10	2.540	31.416	1.2368	10.00	11.666	21.666	21.571
11	2.309	34.558	1.3606	11.00	12.833	23.833	23.728
12	2.117	37.699	1.4843	12.00	14.000	26.000	25.884
13	1.954	40.841	1.6079	13.00	15.166	28.166	28.041
14	1.814	43.982	1.7317	14.00	16.332	30.332	30.198
15	1.693	47.124	1.8541	15.00	17.499	32.499	32.355
16	1.587	50.266	1.9790	16.00	18.666	34.666	34.512
18	1.411	56.549	2.2263	18.00	21.000	39.000	38.826
20	1.270	62.832	2.4737	20.00	23.332	43.332	43.142
22	1.155	69.115	2.7210	22.00	25.665	47.665	47.454
24	1.058	75.398	2.9685	24.00	28.000	52.000	51.768
27	0.941	84.823	3.339	27.00	31.498	58.498	58.239
30	0.847	94.248	3.711	30.00	35.000	65.000	64.713
33	0.770	103.673	4.082	33.00	38.498	71.498	71.181
36	0.706	113.097	4.453	36.00	41.998	77.998	77.652
39	0.651	122.522	4.824	39.00	45.497	84.497	84.123
42	0.605	131.947	5.195	42.00	48.997	90.997	90.594
45	0.564	141.372	5.566	45.00	52.497	97.497	97.065
50	0.508	157.080	6.184	50.00	58.330	108.330	107.855
55	0.462	172.788	6.803	55.00	64.163	119.163	118.635
60	0.423	188.496	7.421	60.00	69.996	129.996	129.426
65	0.391	204.204	8.040	65.00	75.829	140.829	140.205
70	0.363	219.911	8.658	70.00	81.662	151.662	150.997
75	0.339	235.619	9.276	75.00	87.495	162.495	161.775

† Dedendum y profundidad total cuando claro = 0.1666 x Módulo, ó un sexto de módulo.

‡ Profundidad total equivalente al estándar Americano de Profundidad Total de Dientes. (Claro = 0.157 x Módulo).

Para Encontrar	Regla	Fórmula
Diámetro de Paso	Divida el Número de Dientes entre el Paso Diametral	Diámetro de Paso = $\frac{\text{Número de Dientes}}{\text{Paso Diametral}} = DP = \frac{N}{PD}$
Tangente del Ángulo de Paso del Impulsado	Divida el Número de Dientes en el Impulsado entre el Número de Dientes en el Motriz	Tangente del Ángulo de Paso = $\frac{\text{Número de Dientes en el Impulsado}}{\text{Número de Dientes en el Motriz}} = \text{Relación del Impulsado}$
Ángulo de Paso del Motriz	Reste el Ángulo de Paso del Impulsado a 90 grados	Ángulo de Paso = 90 grados - Ángulo de Paso del Impulsado del Motriz
Radio de Cono del Paso	Divida el Diámetro de Paso entre 2 veces el Seno del Ángulo de Paso	Radio de Cono del Paso = $\frac{\text{Diámetro de Paso}}{2 \times \text{Seno del Ángulo de Paso}}$
Tangente del Ángulo del Adendum	Divida el Adendum entre el Radio de Cono del Paso	Tangente del Ángulo del Adendum = $\frac{\text{Adendum}}{\text{Radio de Cono del Paso}}$
Ángulo de Cara	Sume el Ángulo del Adendum al Ángulo de Paso	Ángulo de Cara = Ángulo del Adendum + Ángulo de Paso
Tangente del Ángulo del Dedendum	Divida el Dedendum entre al Radio de Cono del Paso	Tangente del Ángulo del Dedendum = $\frac{\text{Dedendum}}{\text{Radio de Cono del Paso}}$
Ángulo de Raíz	Reste al Ángulo del Dedendum al Ángulo de Paso	Ángulo de Raíz = Ángulo de Paso — Ángulo del Dedendum
Adendum Angular	Multiplique el Adendum por el Coseno del Ángulo de Paso	Adendum Angular = Adendum \times Coseno del Ángulo de Paso
Diámetro Exterior	Sume 2 Adenda Angulares al Diámetro de Paso	Diámetro Exterior = 2 Adendum Angulares + Diámetro de Paso
Distancia de Montaje	Sume un Medio del Diámetro de Paso de la Línea de Paso	Distancia de Montaje = $\frac{\text{Diámetro de Paso}}{2}$ + Línea de Paso de retroceso
Distancia del Centro del Cono a la Corona	Multiplique un medio del Diámetro Exterior por la Cotangente del Ángulo de Cara	Centro de Cono a Corona = $\frac{\text{Diámetro Exterior}}{2} \times \text{Cotangente del Ángulo de Cara}$
Retroceso a Corona	Reste el Centro del Cono a la Corona de la Distancia de Montaje	Retroceso a Corona = Distancia de Montaje - Centro del Cono a Corona
Relación	Divida los Dientes del Impulsado entre los Dientes del Motriz	Relación = $\frac{\text{Número de Dientes del impulsado}}{\text{Número de Dientes del Motriz}}$

Fórmulas para Coronas y Sinfines



(Basado en el Paso Diametral)

Para Encontrar	Regla	Fórmula
Diámetro de Paso de Corona	Divida el Número de Dientes entre el Paso Diametral	Diámetro de Paso = $\frac{\text{Número de Dientes en Corona}}{\text{Paso Diametral}}$
Diámetro de Cuello de Corona	Sume 2 Adenda al Diámetro de Paso	Diámetro de Cuello = $(2 \times \text{Adendum}) + \text{Diámetro de Paso}$
Diámetro Exterior de Corona	Sume 3 Adenda al Diámetro de Paso	Diámetro Exterior = $(3 \times \text{Adendum}) + \text{Diámetro de Paso}$
Diámetro de Paso del Sinfín	Reste el Diámetro de Paso Corona de 2 Veces la Distancia del Centro	Diámetro de Paso del Sinfín = $(2 \times \text{Distancia del Centro}) - \text{Diámetro de Paso del Engrane con Tornillo Sinfín}$
Diámetro Exterior del Sinfín	Sume 2 Adenda al Diámetro de Paso del Sinfín	Diámetro Exterior = $\text{Diámetro de Paso del Sinfín} + 2 \times \text{Adendum}$
Avance del Sinfín	Divida 3.1416 entre el Paso Diametral y Multiplique por el Número de Cuerdas del Sinfín	Avance del Sinfín = $\frac{3.1416}{\text{Paso Diametral}} \times \text{Número de Cuerdas en el Sinfín}$
Cotangente de Ángulo de Hélice del Sinfín	Multiplique el Diámetro de Paso del Sinfín por el Paso Diametral y Divida entre el Número de Cuerdas del Sinfín	Cotangente de Ángulo de Hélice del Sinfín = $\frac{\text{Diámetro de Paso del Sinfín} \times \text{Paso Diametral}}{\text{Número de Cuerdas del Sinfín}}$
Distancia de Centros	Sume el Diámetro de Paso del Sinfín al Diámetro de Paso Divida entre 2	Distancia de Centros = $\frac{\text{Diámetro de Paso} + \text{Diám. de Paso de la Corona}}{2}$
Relación	Divida el Número de Dientes de la Corona entre el Número de Cuerdas del Sinfín	Relación = $\frac{\text{Número de Dientes de la Corona}}{\text{Número de Cuerdas del Sinfín}}$

NOTA: Los Datos de los Dientes (Adendum, Profundidad Total, etc.) son los mismos de los engranes rectos.

Tamaños Comparativos de Dientes de Engranajes

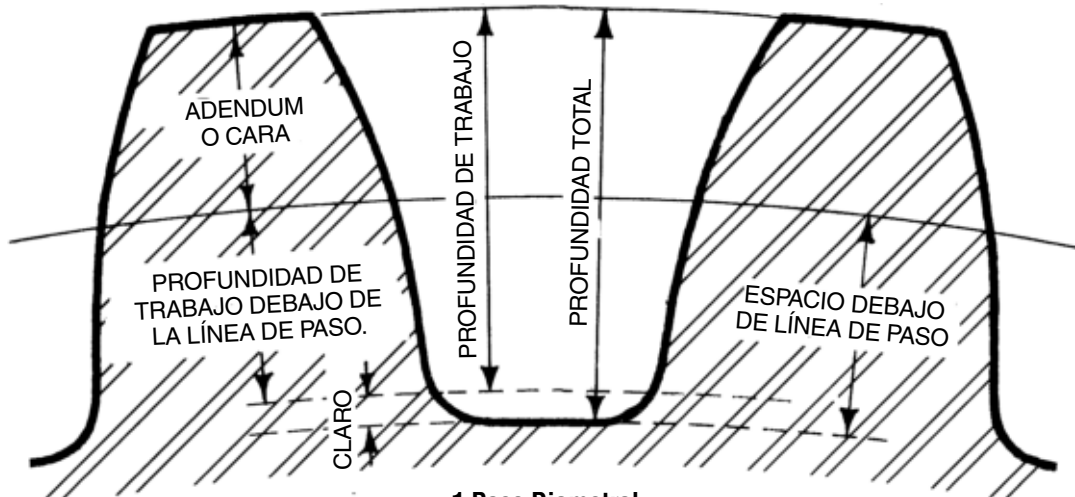

1 Paso Diametral
Paso Circular de 3.1416"

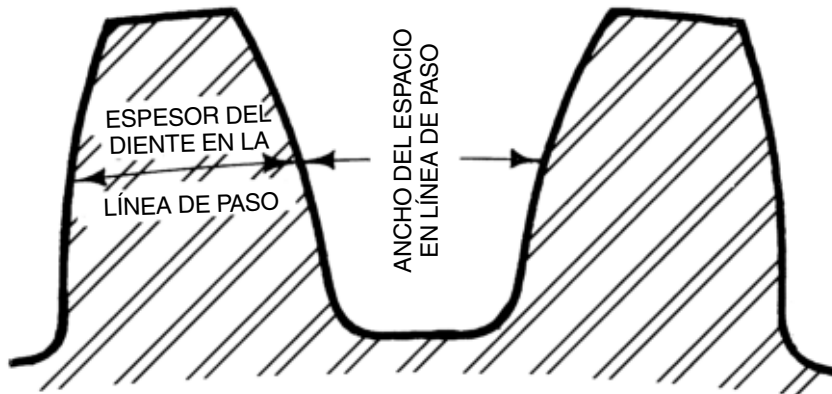

1¼ Paso Diametral
Paso Circular de 2.5133"

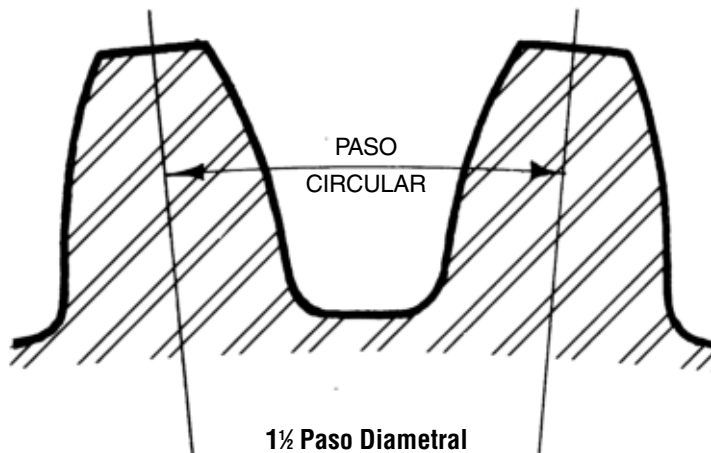

1½ Paso Diametral
Paso Circular de 2.0944"

Perfil de Dientes de los Engranés Rectos

Ángulo de Presión $14\frac{1}{2}^\circ$

Martin

Tamaños Comparativos de Dientes de Engranés

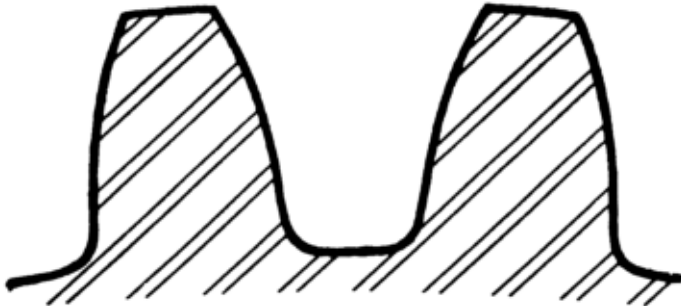

Paso Diametral de $1\frac{1}{4}$
Paso Circular de 1.7952"

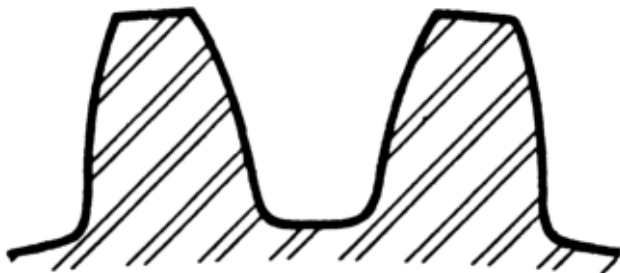

Paso Diametral 2
Paso Circular de 1.5708"



Paso Diametral $2\frac{1}{2}$
Paso Circular de 1.2566"

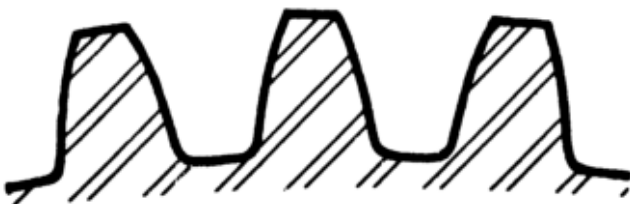

Paso Diametral 3
Paso Circular de 1.0472"

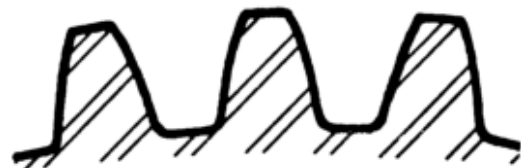

Paso Diametral de $3\frac{1}{2}$
Paso Circular de .8976"

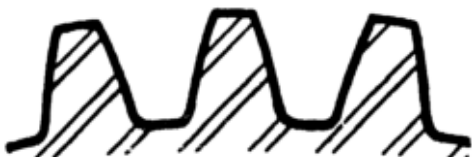

Paso Diametral 4
Paso Circular de .7854"



Paso Diametral 5
Paso Circular de .6283"



Paso Diametral 6
Paso Circular de .5236"

Tamaños Comparativos de Dientes de Engranes

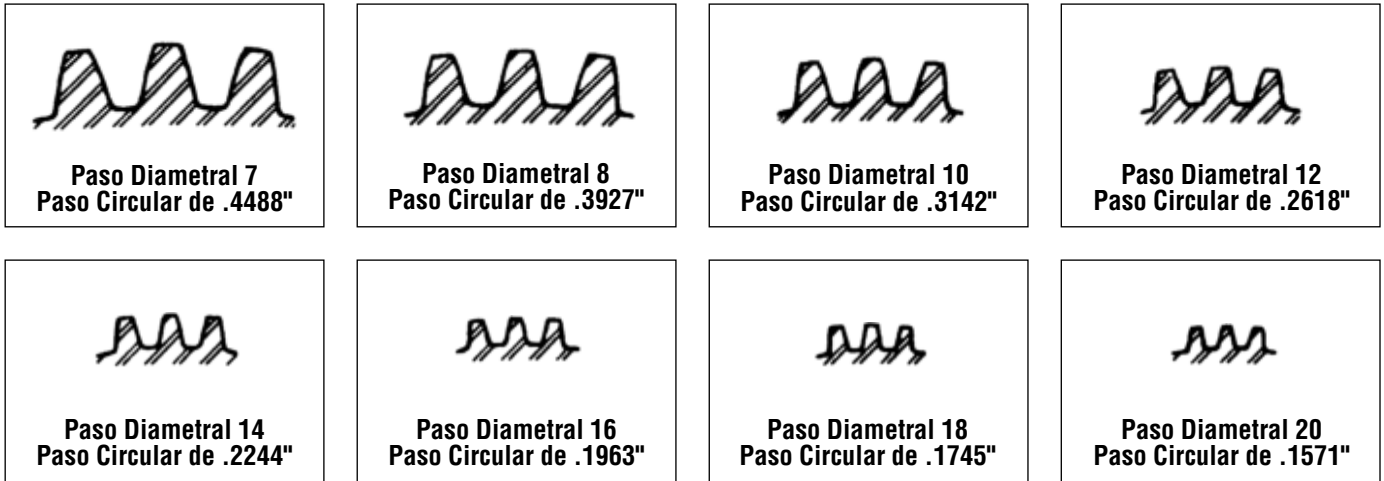

Comparación de Cremalleras — 14½° y 20°

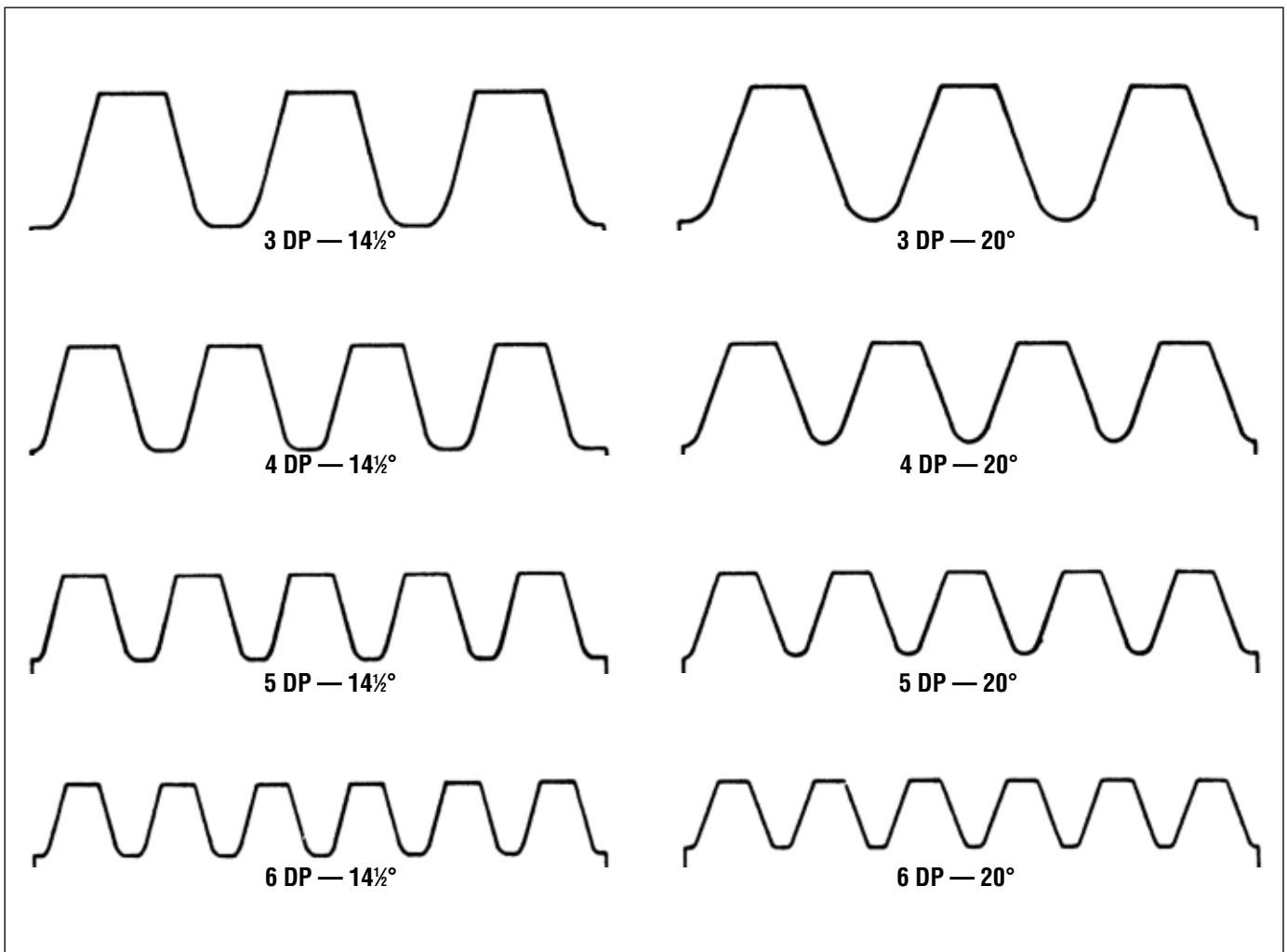

Materiales de Construcción para Engranés Rectos

The logo for Martin, featuring the word "Martin" in a white, stylized, cursive script font on a black rectangular background.

Engranés de Acero en Existencia

Los engranes de acero *Martin* están fabricados de acero al carbón de alta calidad. Este material se usa por su resistencia y por sus excelentes características para endurecimiento. Estos engranes pueden ser endurecidos por cualquier método; por flama o por inducción. El endurecimiento por flama es preferible ya que sólo se endurecen los dientes. La deformación prácticamente se elimina y el barreno queda suave para maquinarse posteriormente.

Engranés de Hierro Fundido

Los engranes *Martin* de hierro fundido están fabricados de hierro de alta calidad con especificaciones de grano fino controlado.

Calibrado de Engranés en Existencia

La mayoría de los engranes *Martin* en existencia pueden ser calibrados. El tamaño máximo del barreno está indicado para cada engrane. En los engranes es especialmente importante mantener el barreno concéntrico con el diámetro de paso. En la mayoría de estos casos se requiere mucho tiempo. Para reducir el tiempo del calibrado, *Martin* mantiene el diámetro exterior de sus engranes concéntrico con el barreno que a su vez es concéntrico con el diámetro de paso. En los pasos más finos se debe tener cuidado de no distorsionar el diámetro exterior al colocar la pieza en el torno.

Los engranes *Martin* de acero están totalmente maquinados.

El recalibrado puede hacerse sujetando la pieza por la maza. Se debe controlar la concentricidad para que los engranes operen con eficiencia.